

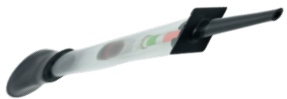

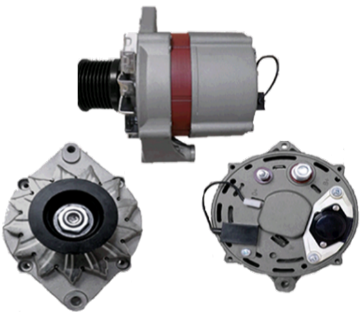







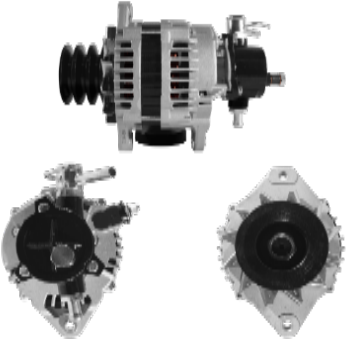
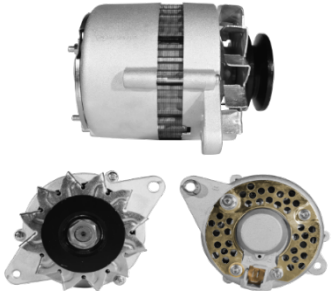





| | | | |
|---|--|---|---|
|  | 2404 | ABRAZADERA GALVANIZADA #00 8MM 1/8" (3MM) - 1/2" (13MM) | TAIWAN |
| | 1626 | ABRAZADERA GALVANIZADA #02 8MM 1/4" (6MM) - 5/8" (16MM) | TAIWAN |
| | 2406 | ABRAZADERA GALVANIZADA #04 8MM 3/8" (10MM) - 5/8" (16MM) | TAIWAN |
| | 2408- | ABRAZADERA GALVANIZADA #06 8MM 1/2" (13MM) - 3/4" (19MM) | TAIWAN |
| | 2412 | ABRAZADERA GALVANIZADA #10 12.7MM 9/16" (14MM) - 1 1/16" (27MM) | TAIWAN |
| | 2416 | ABRAZADERA GALVANIZADA #12 12.7MM 5/8" (16MM) - 7/8" (22MM) | TAIWAN |
| | 2420- | ABRAZADERA GALVANIZADA #16 12.7MM 5/8" (16MM) - 1 1/4" (32MM) | TAIWAN |
| | 2424 | ABRAZADERA GALVANIZADA #24 12.7MM 3/4" (19MM) - 1 3/4" (45MM) | TAIWAN |
| | 2428 | ABRAZADERA GALVANIZADA #24 12.7MM 1 1/4" (32MM) - 2" (50MM) | TAIWAN |
| | 2432 | ABRAZADERA GALVANIZADA #28 12.7MM 1 1/2" (38MM) - 2 1/4" (57MM) | TAIWAN |
| | 2436 | ABRAZADERA GALVANIZADA #32 12.7MM 1 9/16" (40MM) - 2 1/2" (65MM) | TAIWAN |
| | 2438 | ABRAZADERA GALVANIZADA #36 12.7MM 1 13/16" (46MM) - 2 3/4" (70MM) | TAIWAN |
| |  | 94 AZ | ÁCIDOMETRO PARA BATERÍA (MEDIDOR DE ÁCIDO DE BATERÍA) |
|  | 242-12372-11 | ALTERNADOR 12V BO UNIVERSAL JOHN DEERE CON POLEA 120 AMP | GPM |





| | | | |
|---|----------------------|--|------------|
|  | <p>242-2334</p> | <p>ALTERNADOR 12V DE 21SI 160AMP FREIGHTLINER-KENWORTH-MACK-INTERNATIONAL (1-2334-00DR-3)(7685N)</p> | <p>GPM</p> |
|  | <p>242-LR160-448</p> | <p>ALTERNADOR 12V HI CHEVROLET NHR- NKR 4JB1 75 AMP (22246N)</p> | <p>GPM</p> |
|  | <p>242-12536</p> | <p>ALTERNADOR 12V HI CHEVROLET NKR-NPR M/N 4HK1-CANTER 110AMP (2 PIN) (LR110-501)</p> | <p>GPM</p> |
|  | <p>242-501N-PLUS</p> | <p>ALTERNADOR 12V CHEVROLET LUV 1600 96/-MAZDA 323 85/ 40AMP (27020-31090)</p> | <p>GPM</p> |





| | | | |
|---|-----------------------|--|------------|
|  | <p>242-52459-PLUS</p> | <p>ALTERNADOR 12V CHEVROLET SPARK GT-N200-N300 60AMP (9052459)</p> | <p>GPM</p> |
|  | <p>242-510N-PLUS</p> | <p>ALTERNADOR 12V HYUNDAI IX35 2.0 GDI-TUCSON 2.0-KIA SPORTAGE 2.0GDI 120AMP (37300-2E400)</p> | <p>GPM</p> |
|  | <p>242-13702-PLUS</p> | <p>ALTERNADOR 12V HYUNDAI ACCENT HATCHBACK 95-00- ELANTRA 110AMP (37300-22200)</p> | <p>GPM</p> |
|  | <p>242-23910-PLUS</p> | <p>ALTERNADOR 12V MA HYUNDAI ATOS-KIA PICANTO MORNING 70AMP (37300-02550)</p> | <p>GPM</p> |

| | | | |
|---|----------------------|---|------------|
|  | <p>242-513N-PLUS</p> | <p>ALTERNADOR 12V MAZDA 323-626 93-00 (E356-18-300)</p> | <p>GPM</p> |
|  | <p>242-514N-PLUS</p> | <p>ALTERNADOR 12V MAZDA 626 92-97-MATSURI 2.0 91-97 80AMP (FS05-18-300)</p> | <p>GPM</p> |
|  | <p>242-21620</p> | <p>ALTERNADOR 12V VA RENAULT TWINGO 1.0 70 AMP (LS17209)</p> | <p>GPM</p> |

| | | | |
|---|-----------------------|---|---------------|
|  | <p>242-14130</p> | <p>ALTERNADOR 12V NI TOYOTA-DAIHATSU- SUZUKI 50 AMP</p> | <p>GPM</p> |
|  | <p>242-11203-PLUS</p> | <p>ALTERNADOR 12V MI TOYOTA YARIS 1.3 2NZ 06-13-1.5 1NZ 05-16 (27060-21150)</p> | <p>GPM</p> |
|  | <p>242-LR280-708</p> | <p>ALTERNADOR 24V HI CHEVROLET NPR REWARD 4HK1 80 AMP SIN BOMBA</p> | <p>GPM</p> |
|  | <p>TAIWAN-16001</p> | <p>AMPERIMETRO BATERÍA 60-60 TABLERO NEGRO-ARO CROMADO GPM</p> | <p>TAIWAN</p> |

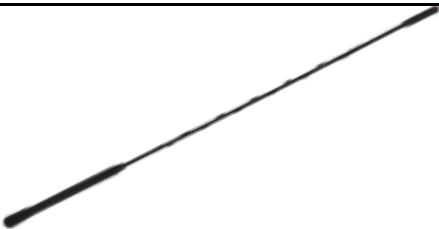
| | | | |
|---|---------------|---|--------|
|  | TAIWAN-16002 | AMPERIMETRO BATERÍA 100-100 TABLERO NEGRO-ARO CROMADO GPM | TAIWAN |
| 216-002 | GPM | | |
|  | TAIWAN-16023 | AMPERIMETRO BATERÍA 60-60 52MM TABLERO NEGRO-ARO CROMADO | TAIWAN |
|  | JBA-325A | ANTENA PARAL NEGRA UNIVERSAL FUNCIÓN VHF/AM/FM MAST 2 SECCIONES EXTENDIBLE 39" CABLE 47" | TAIWAN |
|  | TAIWAN-JBA324 | ANTENA PARAL NEGRA UNIVERSAL FUNCIÓN VHF/AM/FM MAST 3 SECCIONES EXTENSÓN 48" CABLE 47" BLACK | TAIWAN |
|  | DSA-404-PL | ANTENA BASE PLANA METÁLICO FUNCIÓN VHF/AM/FM MAST 3 SECCIONES EXTENSÓN 39" CABLE 47" 180° AJUSTABLE | TAIWAN |

| | | | |
|---|---------------|---|--------|
|  | TAIWAN-JBA413 | ANTENA COLA DE RATON PLASTICA 1 SECCION EXTENSIÓN 16" CABLE 47" 180° AJUSTABLE | TAIWAN |
|  | 303-621 | ANTENA PARA GM CORSA CON CABLE 1.2mts | GPM |
| | DSA-3621 | | TAIWAN |
|  | 303-5391 | ANTENA LUV 2300/TOYOTA HILUX*BASE | KTC |
| | DSA-35391 | | TAIWAN |
|  | 303-404 | ANTENA DE RESORTE CROMADA UNIVERSAL | KTC |





| | | | |
|---|------------------------|--|---------------|
|  | <p>DSA-36061</p> | <p>ANTENA NEGRA UNIVERSAL ESPIRAL 16" CON KIT DE TORNILLOS 5/6mm</p> | <p>TAIWAN</p> |
| | <p>303-832</p> | <p>ANTENA NEGRA UNIVERSAL PEQUEÑA</p> | <p>KTC</p> |
|  | <p>303-320</p> | <p>ANTENA TIPO PIONNER METÁLICO</p> | <p>TAIWAN</p> |
|  | <p>303-604</p> | <p>ANTENA EXTENSIÓN 2MT</p> | <p>KTC</p> |
|  | <p>TAIWAN-46004901</p> | <p>EXTENSIÓN ANTENA 90CM NEGRA</p> | <p>TAIWAN</p> |
| | <p>TAIWAN-46004902</p> | <p>EXTENSIÓN ANTENA 120CM NEGRA</p> | <p>TAIWAN</p> |
| | <p>TAIWAN-46004903</p> | <p>EXTENSION ANTENA 250 CM NEGRA</p> | <p>TAIWAN</p> |

| | | | |
|---|-----------------------|--|---------------|
|  | <p>303-009</p> | <p>BASE ANTENA PARA ESPEJO LATERAL 2 TORNILLOS HORIZONTAL (BLISTER) 1SET</p> | <p>KTC</p> |
| | <p>303-SP006</p> | <p>RESORTE DE LUJO EN ACERO PARA ANTENA DE CAMIÓN</p> | <p>KTC</p> |
|  | <p>TAIWAN-13</p> | <p>ANTISULFATANTE BATERÍA NACIONAL ROJO / NEGRO DM</p> | <p>TAIWAN</p> |
|  | <p>243-16971-PLUS</p> | <p>ARRANQUE 12V NI CHEVROLET SPRINT-SWIFT-STEEM 8D-1.4KW (31100-82011)</p> | <p>GPM</p> |
|  | <p>243-21005</p> | <p>ARRANQUE 12V HI CHEVROLET DMAX-NKR 4JA1-4JB1 DIESEL 2.2kW- 9D (S13-114)</p> | <p>GPM</p> |



| | | | |
|---|-----------------------|--|------------|
|  | <p>243-03400-PLUS</p> | <p>ARRANQUE 12V VA HYUNDAI I10-I30-GRAND ILUSION 0.9KW-8D-CW (36100-03400) GPM</p> | <p>GPM</p> |
|  | <p>243-515N-PLUS</p> | <p>ARRANQUE 12V MAZDA 323-626-B2200-B2600 RELACIONADO 8D-1.0KW (E356-18-400)</p> | <p>GPM</p> |
|  | <p>243-OL180-PLUS</p> | <p>ARRANQUE 12V NI TOYOTA HILUX 2.8L DIESEL 15-18- FORTUNER-INNOVA 1.8KW-10D-CW (28100-OL180)</p> | <p>GPM</p> |
|  | <p>243-32415</p> | <p>ARRANQUE 12V NI TOYOTA VIGO 1KD-2KD 95-16- 4RUNNER 1KZ 95-05-HIACE 5L 2.2KW-10D-CW (28100- 67050-28100-0L041)</p> | <p>GPM</p> |

| | | | |
|--|-----------------------|--|------------|
|  | <p>243-32620-PLUS</p> | <p>ARRANQUE 12V MI SUZUKI SX4 05-12-SWIFT III 1.6 14-16-GRAND VITARA II 05 1.3KW-8D-CW (31100-63J00)</p> | <p>GPM</p> |
|  | <p>243-1739-SIN</p> | <p>ARRANQUE 12V NI 2.7kW CHEVROLET NPR 11D-CW-UNIVERSAL SIN CHOROTE</p> | <p>GPM</p> |
|  | <p>243-50-153-1</p> | <p>ARRANQUE 12V DE 42MT- CW- 11D BRIGADIER-KENWORTH-FREIGHTLINER-VOLVO-MACK (6356N)</p> | <p>GPM</p> |

| | | | |
|---|--------------|--|--------|
|  | 243-16004 | ARRANQUE 24V SA HINO BUSETON GH-GD JO8C 4.5kW-11D (281002624-03555020016) | GPM |
|  | 201-1 | AUTOMÁTICO ARRANQUE 12V DE 28MT GMC- FORD 7000 (66-8405- ZM806) | KTC |
|  | 201-3 | AUTOMÁTICO ARRANQUE 12V NI SPRINT-WFR-SUZUKI-TOYOTA-HONDA-SUBARU (66-8205 - ZM706) | KTC |
|  | TAIWAN-02013 | AUTOMÁTICO ARRANQUE 12V NI SPRINT-WFR-SUZUKI-TOYOTA-HONDA-SUBARU (66-8205 - ZM706) | TAIWAN |
|  | TAIWAN-02014 | AUTOMÁTICO ARRANQUE 12V NI CHEVYTAXI-SUPERCARRY-SUZUKI-HONDA-NISSAN-TOYOTA (66-8210 ZM708) | TAIWAN |
| | 201-4 | | KTC |

| | | | |
|---|--------------|---|--------|
| | 201-6 | AUTOMÁTICO ARRANQUE 24V HI ISUZU NKR- NPR- NISSAN (ZM981) | KTC |
|  | DSA-018 | AUTOMÁTICO ARRANQUE 12V MI MAZDA T- MIT PICKUP- MONTERO-DIESEL ENGINES- HYUNDAI-DODGE RAM 2.3L (66-8331-ZM893) | TAIWAN |
| | 201-8 | | KTC |
|  | 201-9 | AUTOMÁTICO ARRANQUE 12V MI TIPO PUNTILLA MAZDA 323 MODELO NUEVO-HYUNDAI MANDO ATOS-H100- ELANTRA-SONATA-MIT.GALANT (66-8326)(ZM697) | KTC |
| | TAIWAN-02019 | | TAIWAN |
|  | 201-10 | AUTOMÁTICO ARRANQUE 12V BO R9- CLIO- VW GOLF- FIAT- PEUGEOT-AUDI (66-9126 -ZM573) | KTC |
|  | 201-11 | AUTOMÁTICO ARRANQUE 12V BO MERCEDES BENZ- JHON DEERE- IVECO- MASSEY FERGUSON (66-9100-1 - ZM531) | KTC |

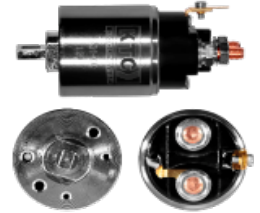
| | | | |
|---|---------------|--|--------|
|  | 201-13 | AUTOMÁTICO ARRANQUE 12V DE BLAZER- AVEO-OPTRA-SPARK- HYUNDAI ATOS 3H (66-132-1/ZM860) | KTC |
|  | TAIWAN-020113 | AUTOMÁTICO ARRANQUE 12V DE BLAZER- AVEO-OPTRA-SPARK- HYUNDAI ATOS 3H (66-132-1/ZM860) | TAIWAN |
|  | 201-15 | AUTOMÁTICO ARRANQUE 12V DE 42MT BRIGADIER (66-113) (ZM-456) | KTC |
| | TAIWAN-20115 | | TAIWAN |
|  | 201-17 | AUTOMÁTICO ARRANQUE 12V DE 37MT KODIAK (66-117 - ZM452) | KTC |
| | TAIWAN-0117 | | TAIWAN |
|  | 201-21 | AUTOMÁTICO ARRANQUE 12V FO FORD BRONCO-RANGER-F150-F250-F350-EXPLORER TIPO PUNTILLA (66-205 - ZM760) | KTC |

| | | | |
|--|---------------|--|--------|
|  | 201-25 | AUTOMÁTICO ARRANQUE 12V CORSA 1.0- 1.3-1.4 (ZM591) | KTC |
|  | 201-48 | AUTOMÁTICO ARRANQUE 12V DELCO 39MT (66-155 - ZM841) | KTC |
|  | 201-60 | AUTOMÁTICO ARRANQUE 12V HI NISSAN MT3000- TD27-D21-FRONTIER-URVAN-TERRANO-DMAX-NKR (66-8159-ZM1981) | KTC |
| | 20160-DS | | TAIWAN |
|  | TAIWAN-020165 | AUTOMÁTICO ARRANQUE 12V MI HYUNDAI-FORD-MAZDA 3-6-M.PAJERO3.0-GALANT-NISSAN PATROL-SUNNY (66-8327 - ZM698) | TAIWAN |
| | 201-65 | | KTC |
|  | 201-67 | AUTOMÁTICO ARRANQUE 12V NI 2.5KW 3 TERMINALES (66-8216) | KTC |

| | | | |
|---|----------|---|--------|
|  | DSA-0173 | AUTOMÁTICO ARRANQUE 12V HI SENTRA-SUNNY-MICRA-DMAX DIESEL-CORSA DIESEL-YANMAR (66-8109)(ZM-710) | TAIWAN |
| | 201-73 | | KTC |
|  | 201-76 | AUTOMÁTICO ARRANQUE 12V DE 29MT MOTOR CUMMINS FORD-FREIGHLINER-KENWORTH-MERCEDES BENZ-STERLING (66-158) | KTC |
|  | DSA-178 | AUTOMÁTICO ARRANQUE 12V VA H. ACCENT 11-17-I20-KIA KARENS-SOUL 09-13-RIO 12-15-CERATO-FORTE (66-9464)(ZM-391) | TAIWAN |
| | 201-78 | | KTC |
|  | 201-80 | AUTOMÁTICO ARRANQUE 12V BO LOGAN-SANDERO-STEPWAY-DUSTER-SYMBOL (ZM-6271) (F000CD1113) | KTC |
|  | DSA-0181 | AUTOMÁTICO ARRANQUE 12V VA H.I10-GETZ-KIA PICANTO-MORNING-VISION (ZM1391)(36100-02560) | TAIWAN |
| | 201-81 | | KTC |

| | | | |
|---|----------|--|--------|
|  | 201-82 | AUTOMÁTICO ARRANQUE ARRANQUE 12V VA H.I30-HB20-ELANTRA-KIA CARENS-SOUL-RONDO (ZM-2391)(36100-2B110) | KTC |
|  | 201-83 | AUTOMÁTICO ARRANQUE 12V VA DUSTER-LOGAN-SANDERO-CLIO-KANGOO-MEGANE (ZM7492)(594438) | KTC |
|  | DSA-0184 | AUTOMÁTICO ARRANQUE 12V DE I10-PICANTO-SPARK GT-TUCSON-IX35-SANTAFE- SPORTAGE-CARENS-CERATO (ZM1261)(66-190) | TAIWAN |
| | 201-84 | | KTC |
|  | 201-85 | AUTOMÁTICO ARRANQUE 12V VA H.ELANTRA-I30 07-KIA SPORTAGE 07-SPECTRA (ZM-392) | KTC |
| | 201-89 | AUTOMÁTICO ARRANQUE 24V MI FUSO-FUSO CANTER-IVECO CURSOR-MAN-VOLVO (ZM5-897- SNLS7531) | KTC |
|  | 201-90 | AUTOMÁTICO ARRANQUE 12V HI CHEVROLET TROOPER 3.2L-3.5L (ZM717-SNLS6241) | KTC |

| | | | |
|---|----------|---|--------|
|  | 201-91 | AUTOMÁTICO ARRANQUE 12V DE AVEO- CORSA 11-16 - SPARK 13-16-ONIX-SPIN-MONTANA (ZM261) | KTC |
| | 201-95 | AUTOMÁTICO ARRANQUE 24V HI NKR-NPR REWARD (ZM3982 - 8971617890) | KTC |
|  | 201-96 | AUTOMÁTICO ARRANQUE 12V NI TOYOTA VIGO HILUX-RAV4-YARIS-COROLLA CONECTOR IZQUIERDO (ZM-425) | KTC |
|  | DSA-1100 | AUTOMÁTICO ARRANQUE 12V VA SAIL-SONIC-AVEO (ZM-6494) | TAIWAN |
| | 201-100 | | KTC |
|  | 201-101 | AUTOMÁTICO ARRANQUE 12V VA DUSTER-LOGAN-SANDERO-CLIO-SCENIC 07-15 (ZM-8494) | KTC |

| | | | |
|---|-----------|--|--------|
|  | 201-103 | AUTOMÁTICO ARRANQUE 12V VA LOGAN-SANDERO-SYMBOL-CLIO-N.MARCH (ZM-2498) | KTC |
| | DSA-01103 | | TAIWAN |
|  | DSA-01104 | AUTOMÁTICO ARRANQUE 12V DE AUXILIAR 29MT-37MT-41MT-42MT (ZM3407 - 10515812 - 67-1816) | TAIWAN |
|  | 201-111 | AUTOMÁTICO ARRANQUE 12V BO TOYOTA HILUX VIGO-FORTUNER-HIACE DIESEL 01-05 (ZM3978-281500L070) | KTC |
|  | 201-113 | AUTOMÁTICO ARRANQUE 12V DE AVEO-SPARK 1.0-1.2-MATIZ 05 (ZM-3261) | KTC |
|  | 201-16004 | AUTOMÁTICO ARRANQUE 24V SA HINO GD-GH SAWAFUJI (28150-78061 - SS2728) | KTC |

| | | | |
|---|----------------|---|--------|
|  | 20126-DS | AUTOMÁTICO ARRANQUE 12V UNIVERSAL TRABAJO CONTINUO 4 TERMINALES (67-702) | TAIWAN |
| | 201-26 | | KTC |
|  | DSA-020188 | AUTOMÁTICO ARRANQUE 24V UNIVERSAL TRABAJO CONTINUO 4 TERMINALES (67-703) | TAIWAN |
| | 201-88 | | KTC |
|  | TSM-18022 | AUTOMÁTICO ARRANQUE 12V DELCO 28MT *NEGRO* WHIT66 | TAIWAN |
|  | 201-77 | AUTOMÁTICO ARRANQUE 12V FORD UNIVERSAL ROJO | KTC |
| | DSA-SW3 | | TAIWAN |
| | 201-94 | AUTOMÁTICO ARRANQUE 24V FORD UNIVERSAL ROJO | KTC |
| | SW-3-24V | | TAIWAN |
|  | DSA-88107-2RS | 88107-2RS BALINERA CARDÁN DODGE 300\600-FORD 600 35mmx72mmx17mm 200gramos | TAIWAN |
| | DSA-88508-2RS | | TAIWAN |
| | DSA-88508A-2RS | HB88508A SOPORTE CARDÁN TRITON/NPR/CHEYENNE F600/350/C30/ X-17 40mmx72mmx22mm 320gramos | TAIWAN |
| | DSA-88512-2RS | 88512-2RS BALINERA CARDÁN BRIGADIER-FORD -9000 60mmx110mmx36mm 963gramos | TAIWAN |
| | DSA-88509-2RS | HB88509 BALINERA CARDAN CHEVROLET-FORD-VOLKSWAGEN-VOLVO-MERCEDES BENZ-IVECO | TAIWAN |
| | DSA-88510-2RS | 88510-2RS BALINERA CARDAN FORD-MERCEDES BENZ-VOLKSWAGEN-RENAULT 50mmx90mmx22mm 554 gramos | TAIWAN |
| | 6000-2RS | BALINERA ALTERNADOR 6000 DELCO MITSUBISHI / NIPPONDENSO | TAIWAN |



| | | |
|-----------------|---|--------|
| 6001-2RS | BALINERA ALTERNADOR 6001 BOSCH HITACHI / NIPPONDENSO / NISSAN | TAIWAN |
| 6002-2RS | BALINERA ALTERNADOR 6002 NIPPONDENSO: MITSUBISHI / HITACHI / TOYOTA / HONDA | TAIWAN |
| 6003-2RS | BALINERA ALTERNADOR 6003 NIPPONDENSO 24V: MITSUBISHI | TAIWAN |
| 6004-2RS | BALINERA ALTERNADOR 6004 HITACHI NIPPONDENSO/NISSAN | TAIWAN |
| 6005-DSA | BALINERA ALTERNADOR 6005 | TAIWAN |
| 6006-2RS | BALINERA ALTERNADOR 6006 MACK CAMIÓN / VOLQUETA | TAIWAN |
| 607-2RS | BALINERA ALTERNADOR 607 MAQUINARIA PESADA Y HERRAMIENTA | TAIWAN |
| 608-2RS | BALINERA ALTERNADOR 608 DELCOB HITACHI / MITSUBISHI | TAIWAN |
| 6200-2RS | BALINERA ALTERNADOR 6200 PARIS RHONE: TOYOTA | TAIWAN |
| 6202-2RS | BALINERA ALTERNADOR 6202 BOSCH / DELCO REMY RENAULT / MITSUBISHI | TAIWAN |
| 6203-2RS | BALINERA ALTERNADOR 6203 FORD : DELCE / LEECE NEVILLE | TAIWAN |
| 6204-2RS | BALINERA ALTERNADOR 6204 LEECE NEVILLE MAZDA / RENAULT | TAIWAN |
| 6205-2RS | BALINERA ALTERNADOR 6205 DELCO MITSUBISHI / LEECE NEVILLE | TAIWAN |
| 6206-2RS | BALINERA ALTERNADOR 6206 LEECE NEVILLE TOYOTA / NISSAN | TAIWAN |
| 6207-2RS | BALINERA ALTERNADOR 6207 TOYOTA / CATERPILAR | TAIWAN |
| 6300-2RS | BALINERA ALTERNADOR 6300 BOSCH : DODGE / FIAT | TAIWAN |
| 6301-2RS | BALINERA ALTERNADOR 6301 MITSUBISHI | TAIWAN |
| 6302-2RS | BALINERA ALTERNADOR 6302 HITACHI : MITSUBISHI | TAIWAN |
| 6303-2RS | BALINERA ALTERNADOR 6303 DELCO MITSUBISHI / FORD / CATERPILAR | TAIWAN |
| 6304-DSA | BALINERA ALTERNADOR 6304 | TAIWAN |
| 6305-2RS | BALINERA ALTERNADOR 6305 DELCO FORD / LEECE NEVILLE / NIPPONDENSO | TAIWAN |
| 6306-DSA | BALINERA ALTERNADOR 6306 | TAIWAN |
| 6307-2RS | BALINERA ALTERNADOR 6307 MOTOR INDUSTRIAL Y CAMIÓN | TAIWAN |
| 949100-3480-2RS | BALINERA ALTERNADOR CHEVROLET / TOYOTA / DAHATSU | TAIWAN |
| 202-450 | BENDIX MI MAZDA 323-626-HYUNDAI ATOS-VERNA-SONATA-ACCENT 110-MONTERO-KIA SEDONA-VITARA 8D | KTC |

| | | | |
|---|-----------|--|--------|
|  | DSA-2450 | BENDIX ARRANQUE DE 40MT-42MT-50MT P900- (54-8306) | TAIWAN |
|  | 202-482 | BENDIX ARRANQUE BO CORSA-CLIO-R9-R18-TWINGO- VW GOLF-GOL-FIAT-FORD 9D (54-9140-1) | KTC |
| | 202482-DS | | TAIWAN |
|  | 202-624 | BENDIX ARRANQUE 37MT KODIAK-INTERNATIONAL- CUMMINS-MERCEDES BENZ-JOHN DEERE 12D (54-132) | KTC |
| | 202624-DS | | TAIWAN |
|  | 202-625 | BENDIX ARRANQUE DE 37MT KODIAK- C-70 DIESEL- INTERNATIONAL-CUMMINS- FORD-CATERPILLAR 10D (54- 131) | KTC |
|  | 202-770 | BENDIX ARRANQUE DAEWOO BAJITO-ASTRA-BLAZER- VECTRA-ZAFIRA-CIELO-ESPERO 9D (54-157) | KTC |
| | 202770-DS | | TAIWAN |
|  | 202-0097 | BENDIX ARRANQUE DE 40MT- 42MT- 50MT P900- CATERPILLAR-CUMMINS-FORD 12D (54-124) | KTC |

| | | | |
|---|------------|--|--------|
|  | 202-0110 | BENDIX DE 40MT- 42MT-50MT CATERPILLAR-CUMMINS- JOHN DEERE-MASSEY FERGUSON 11D (54-123-1) | KTC |
|  | 202-0144- | BENDIX ARRANQUE MI MAZDA- SUZUKI-HYUNDAI 9D (54- 8305) | KTC |
|  | 202-0352 | BENDIX ARRANQUE MAZDA-MONTERO-HYUNDAI-KIA SPORTAGE 2.0 8D (54-8304) | KTC |
|  | 202-0576 | BENDIX ARRANQUE SPRINT SWIFT 1.3-1.0-SUZUKI 8D (54- 8221) | KTC |
| | 2020576-DS | | TAIWAN |
|  | 202-0595 | BENDIX ARRANQUE MI HYUNDAI H100-TRACKER- SANTAFE- MAZDA B2000- MONTERO V6- VITARA-ECLIPSE- GALANT 8D (54-8313) | KTC |
|  | 2020596-DS | BENDIX ARRANQUE MAZDA MATSURI-B2200- FORD | TAIWAN |

| | | | |
|---|----------|--|-----|
|  | 202-0596 | PROBE- MITSUBISHI MONTERO 10D (54-8314) | KTC |
|  | 202-0620 | BENDIX ARRANQUE FO FORD 150-RANGER-BRONCO-VANS-ESCAPE 10D (54-212) | KTC |
|  | 202-0790 | BENDIX ARRANQUE NISSAN-NPR-D.MAX | KTC |
|  | 202-0808 | BENDIX ARRANQUE NI SWIFT 1.3 INJECTION-SPRINT-JIMMY-DAIHATSU TERIUS-DATSUN (54-8234) | KTC |
|  | 202-0809 | BENDIX ARRANQUE NI TOYOTA COROLLA 1.3-1.6-TERCEL-CELICA-HONDA CIVIC (54-8232) | KTC |
|  | 202-0836 | BENDIX ARRANQUE MI RENAULT CLIO 1.1-1.2-1.4-R19-R21-PEUGEOT 106-206-CITROEN SAXO -XSARA 9D | KTC |

| | | | |
|---|-------------|---|--------|
|  | 202-0947 | BENDIX ARRANQUE NI LUV 2300-TROOPER-TOYOTA RELACION-SUZUKI GEO-SPORTAGE 9D (54-8202) | KTC |
| | 2020947-DS | | TAIWAN |
|  | 2020965-DS | BENDIX VA RENAULT CLIO 1.2-LOGAN 1.0-KANGOO- TWINGO 1.2-PEUG.106-206- FIESTA-ECOSPORT-PAL 9D (54-943) | TAIWAN |
| | 202-0965 | | KTC |
|  | 20210003-DS | BENDIX DE CHEVROLET AVEO-OPTRA-CAPTIVA-ZAFIRA- COBALT-TRAILBLAZER-SILVERADO-FIAT PALIO 9D (54- 173) | TAIWAN |
|  | 202-1024 | BENDIX MI MAZDA BT-50 -PAJERO L200-L300 DIESEL- FORD RANGER 2.5L-SUZUKI 10D (54-8343) | KTC |
|  | 202-1048 | BENDIX DE DAEWOO MATIZ-SPARK-CRONOS-TICO- KIA RIO-SPORTAGE 8D (54-9901) | KTC |
| | DSA-21048 | | TAIWAN |

| | | | |
|---|-----------|---|--------|
|  | 202-1064 | BENDIX ARRANQUE VA MEGANE 1.4-1.6-CLIO 1.6 16V-SCENIC 2.0-LOGAN 1.4L 16V-SYMBOL (54-9449) | KTC |
|  | 202-1607 | BENDIX ARRANQUE VA HYUNDAI H100-H1 GRAND-PORTER-KIA PREGIO-PAJERO-RENAULT MASTER TRAFFIC (809042) | KTC |
|  | 202-1509 | BENDIX ARRANQUE LU SUZUKI ALTO-ATOS-VISION-SANTRO-ESTEEM-LANCER 8D (262562877) | KTC |
| | DSA-21509 | | TAIWAN |
|  | 202-1674 | BENDIX ARRANQUE BO LOGAN-SANDERO-MEGANE 08 8D (F000CD1114) | KTC |
|  | 202-1735 | BENDIX ARRANQUE VA RENAULT DUSTER-SANDERO-LOGAN-KANGOO-CLIO-FLUENCE-SCENIC (361002G200) | KTC |

| | | | |
|---|--------------------|--|---------------|
|  | <p>2021770-DS</p> | <p>BENDIX ARRANQUE VA HYUNDAI H100-H1 GRAND-PORTER-KIA PREGIO-PAJERO-RENAULT MASTER TRAFFIC (809042)</p> | <p>TAIWAN</p> |
|  | <p>20210003-DS</p> | <p>BENDIX ARRANQUE AVEO-OPTRA-CAPTIVA-ZAFIRA-COBALT-TRAILBLAZER-SILVERADO-FIAT PALIO 9D (54-173)</p> | <p>TAIWAN</p> |
|  | <p>202-1893</p> | <p>BENDIX ARRANQUE VA VW GOL 97-14-POLO 02-16-FOX 03-13-VOYAGE 11D CCW</p> | <p>KTC</p> |
|  | <p>202-2003</p> | <p>BENDIX ARRANQUE SA HINO GD-GH-BUSETON J07C-J08C-TOYOTA DYNA 11D-CW (28251-1022)</p> | <p>KTC</p> |
|  | <p>202-8970</p> | <p>BENDIX ARRANQUE NI CHEVROLET NPR REWARD CCW 11D</p> | <p>KTC</p> |

| | | | |
|---|-------------|--|--------|
|  | 203-001 | BOBINA IGNICIÓN CARGA SECA UNIVERSAL | KTC |
| | MIC-2000P | | TAIWAN |
|  | 203-008 | BOBINA IGNICIÓN CHEVROLET AVEO-SPARK-7.24-CORSA-SUZUKI FORENZA-RENO (3 PINES) (33410-84Z00 - UF503) | KTC |
| | UF-503X | | TAIWAN |
|  | 25186687-DS | BOBINA IGNICIÓN CHEVROLET AVEO 09-11- SONIC 1.6-TRACKER 1.6-CRUZE 11-15 CON MODULO INCORPORADO 7P (25186687) | TAIWAN |
|  | 203-035 | BOBINA IGNICIÓN CHEVROLET AVEO 09-11- SONIC 1.6-TRACKER 1.6-CRUZE 11-15 CON MODULO INCORPORADO 7P (25186687) | KTC |
|  | 203-064 | BOBINA IGNICIÓN CHEVROLET SAIL 10-14- SONIC 11-12 TIPO LAPICERO 3P (9023781) | KTC |
| | 203-3781DS | | TAIWAN |

| | | | |
|---|---------|---|-----|
|  | 203-081 | BOBINA IGNICIÓN CHEVROLET CAPTIVA SPORT-COBALT-HHR 4P (12638824-RUF645) | KTC |
|  | 203-046 | BOBINA IGNICIÓN HYUNDAI ACCENT 1.6 -VISION 1.4-GETZ-ELANTRA-CERATO-RIO-SEPHIA-EXCITE (2730126600) | KTC |
|  | 203-047 | BOBINA IGNICIÓN HYUNDAI ACCENT-RIOVISION-RIO 1.6-EXCITE 2P (27301-26640 - CUF499) | KTC |
|  | 203-010 | BOBINA IGNICIÓN HYUNDAI ACCENT-VISION-VERNA-VERACRUZ (2730122600) | KTC |
|  | 203-050 | BOBINA IGNICIÓN HYUNDAI TUCSON IX35-ELANTRA-KIA SOUL-FORTE-SPORTAGE REVOLUTION (27300-2E000-CUF651) | KTC |

| | | | |
|--|------------|---|--------|
|  | 203-051 | BOBINA IGNICIÓN HYUNDAI I10-KIA PICANTO MORNING 1.0 2P (27301-0400) | KTC |
| | 203-060 | BOBINA IGNICIÓN HYUNDAI ACCENT-I30-KIA RIO-CERATO-SOUL (27301-2B010) | KTC |
|  | 203-055 | BOBINA IGNICIÓN RENAULT LOGAN - SANDERO - MEGANNE - KANGOO | KTC |
| TAIWAN-03055 | TAIWAN | | |
|  | 7700107177 | BOBINA IGNICIÓN RENAULT CLIO- MEGAN-LOGAN-DUSTER-SANDERO- KANGOO-SYMBOL-LAGUNA (UF653 245104) | TAIWAN |
| 203-003 | KTC | | |
| | 203-059 | BOBINA IGNICIÓN MAZDA ALLEGRO-323-MX5 II (ZL0118100) | KTC |

| | | | |
|---|------------|--|--------|
|  | 203-068 | BOBINA IGNICIÓN MAZDA 2 03-15 - MAZDA 3 03-14 3P (ZJ49-18-100) | KTC |
|  | 203-048 | BOBINA IGNICIÓN MAZDA 3 SPORT-6-CX7-MX5 MIATA 3P (L3G218100A) | KTC |
|  | 203-019 | BOBINA IGNICIÓN NISSAN TSURU III-SENTRA B13-B14-FRONTIER PICK UP-D21-COROLLA (22433-F4302) | KTC |
|  | 203-4014DS | BOBINA IGNICIÓN NISSAN TIIDA 1.8-MARCH 1.6-MICRA 1.4-SENTRA 2.0 3P (221604014) | TAIWAN |
| | 203-042 | | KTC |
|  | 203-043 | BOBINA IGNICIÓN NISSAN SENTRA 1.6-1.8-2.0-TIIDA-VERSA-XTRAIL-ALTIMA 3P (22448JA00A-CUF549) | KTC |

| | | | |
|---|------------|--|--------|
|  | 203-2448DS | BOBINA IGNICIÓN NISSAN ALTIMA BAIXIND 3 | TAIWAN |
|  | 203-070 | BOBINA IGNICIÓN HONDA CIVIC (06-11)-ACCORD 08-12 (CUF582-30520-RNA-A01) | KTC |
|  | 203-098 | BOBINA IGNICIÓN TOYOTA PRADO 00-04-4RUNNER-TACOMA (90919-02237-UF323) | KTC |
|  | 203-099 | BOBINA IGNICIÓN TOYOTA HILUX- 4RUNNER-BURBUJA-CELICA-CAMRY-LEXUS (90919-02197-UF72) | KTC |
|  | 203-067 | BOBINA IGNICIÓN TOYOTA COROLLA 09-17-SCION 08-14-MATRIX-PRIUS 09-15 (90919-02258-CUF596) | KTC |



203-062

BOBINA ENCENDIDO TOYOTA COROLLA 00-08-CELICA 00-05 4P (90919-02239)

KTC

203-016

BOBINA IGNICIÓN TOYOTA YARIS 00-10-ECHO 00-05-SCION XA-XB 03-06 (CUF316)

KTC



203-9091DS

BOBINA IGNICIÓN TOYOTA HILUX VIGO-4RUNNER-CRUISER-COROLLA-TACOMA-HIGHLANDER 4P (9091902248-CUF495)

TAIWAN



203-061

BOBINA IGNICIÓN FORD FIESTA-ESCAPE-FOCUS-FUSION-MAZDA 6 (4M5G-12A366BC-CFD505)

KTC



203-011

BOBINA IGNICIÓN FORD F150-F350-EXPLORER-EXCURSION-RANGER-TRITON (IL2U12029AA)



KTC



DSA-3025201

BOBINA IGNICIÓN ELECTRONICA TIPO BOSH





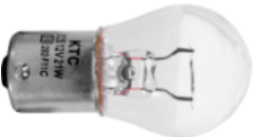

TAIWAN



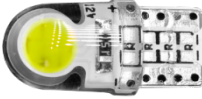

| | | | |
|---|--------------|---|--------|
|  | 3024201 | BOBINA IGNICIÓN RESISTENCIA INTERNA CON ABRAZADERA *CIZ-500 | TAIWAN |
|  | 003024101-EX | BOBINA IGNICIÓN RESISTENCIA EXTERNA LB88 | TAIWAN |
|  | TAIWAN-505 | BOBINA COMPRESOR 505 12V AIRE ACONDICIONADO | TAIWAN |
|  | 227-001 | BOMBA GASOLINA SWIFT 1.0-1.3-1.6-SPRINT- ESTEEM- LANCER 1.3-1.5-SUZUKI (15110-63B00) 0.1BAR- 80L/H | KTC |
|  | 227-003 | BOMBA GASOLINA TOYOTA YARIS-VIGO-4RUNNER- FORTUNER-COROLLA-GRAND VITARA- D.TERI (23220-21132) 3 BAR-8 | KTC |
|  | 227-005 | BOMBA GASOLINA UNIVERSAL CUADRADA PARA CARROS CON CARBURADOR 5-9PSI- 70 L/H | KTC |
| | EP-40107 | | TAIWAN |

| | | | |
|---|------------|---|--------|
|  | 227-007 | BOMBA GASOLINA PILA T.FACET REDONDA PARA CARROS CON CARBURADOR 5-9PSI - 100L/H (E8012S) | KTC |
| | EP-80125 | | TAIWAN |
|  | 227-008 | BOMBA GASOLINA UNIVERSAL CORSA- KIA- FRONTIER- OPTRA-SENTRA-SPARK (E2068-0580453407) 3.0BAR-105L/H | KTC |
|  | UC-V4 | BOMBA GASOLINA PILA CHEVROLET SUPER CARRY *PILA | TAIWAN |
|  | 1511063B01 | BOMBA GASOLINA PILA CHEVROLET SWIFT 1.3-1.6 | TAIWAN |
|  | 227-500 | BOMBA GASOLINA MOTO HONDA CG150 MIX-CG160 FAN-TITAN-CARGO-NXR 160 BROS ESD-ESDD 2.5BAR-40LH (16710KVSF02) | KTC |

| | | | |
|--|------------|--|--------|
|  | 227-501 | BOMBA GASOLINA MOTO HONDA CG160 STAR ES-NXR 160 BROSS ESD-ESDD-XR190-CB190 2.5BAR-40LH (16797-KRE-H81) | KTC |
|  | 227-509 | BOMBA GASOLINA MOTO YAMAHA NMAX-YZF-R15-R125-155-MTN125-BK6 (HD-2HP-E3907) | KTC |
|  | DSA-M20231 | MANGUERA PARA CONEXIÓN BOMBA PILA GASOLINA UNIVERSAL. 26-23CM8MM23CM | TAIWAN |
|  | 204-081 | BOMBILLO 1141 12V 1C 21W S25 BA15S LUZ DIRECCIONAL | KTC |
| | 1141-12V | DELANTERA Y TRASERA | TAIWAN |
| | 204-083 | BOMBILLO 1141 24V 1C 21W S25 BA15S LUZ DIRECCIONAL | KTC |
| | 1141-24V | DELANTERA Y TRASERA | TAIWAN |
| | 204-186 | BOMBILLO 1141 24V 1C 21W S25 BA15S LUZ DIRECCIONAL DELANTERA Y TRASERA COLOR NARANJA | KTC |

| | | | |
|---|----------------|---|--------|
|  | 322-070W-12V | BOMBILLO 1141 12V 20LED BLANCO 5730SMD 1 CONTACTO | KTC |
| | 67-12V | BOMBILLO 67 12V 5W BA15S T16 LUZ PLACA-TRASERA- | TAIWAN |
| | 204-130 | DELANTERA-TABLERO | KTC |
| | 204-225 | BOMBILLO 12V 67 10W BA15S T16 LUZ PLACA-TRASERA- | KTC |
| | 204-134 | DELANTERA-TABLERO | KTC |
| | 204-078 | BOMBILLO 1034 12V 2C 21/5W S25 BAY15D LUZ DE FRENO | KTC |
| | 1034-12V | PATICOJO | TAIWAN |
| | 204-080 | BOMBILLO 1034 24V 2C 21/5W S25 BAY15D LUZ DE FRENO | KTC |
| | 1034-24V | PATICOJO | TAIWAN |
| | 204-079 | BOMBILLO 1034 12V 2C 21/5W S25 BAY15D LUZ DE FRENO NARANJA | KTC |
|  | 322-070DPW-12V | BOMBILLO 1034 12V 2C 20LED BLANCO 5730 SMD BAZ15D | KTC |
| | 204-109 | BOMBILLO 1034 12V BOMBA PEQUEÑA AT21 2C 21/5W BAY15D G18.5 LUZ DE FRENO | KTC |
|  | 322-051DW-12V | BOMBILLO 1034 12V 9 LED BLANCO 2835 SMD 2 CONTACTO 12V 2PCS | KTC |
| | TAIWAN-53-12V | BOMBILLO 53 12V 4W BA9S T8.5 LUZ TABLERO-TRASERA | TAIWAN |
| | 204-108 | POSICION-GUANTERA | KTC |
| | 204-133 | BOMBILLO 53 24V 4W BA9S T8.5 TABLERO TIPO BALA | KTC |

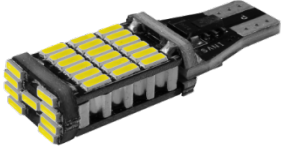

| | | | |
|---|----------------|--|--------|
|  | 322-024W-12V | BOMBILLO 53 12V 4LED BLANCO 2835SMD | KTC |
| | 204-227 | BOMBILLO H21W 12V 21W LUZ ANGEL VOLKSWAGEN JETTA-BORA-MERCEDEZ | KTC |
| | 204-191 | BOMBILLO 2721 T5 12V CON CONTACTOS LARGOS TABLEROS | KTC |
| | 204-192 | BOMBILLO 2721 T5 24V CON CONTACTOS LARGOS TABLEROS | KTC |
| | 204-092- | BOMBILLO 2721 T5 12V 1.2W LUZ TERCER STOP TRASERO-TABLERO | KTC |
| | 204-111 | BOMBILLO 2721 T5 24V 1.2W LUZ TERCER STOP TRASERO-TABLERO | KTC |
|  | 322-016W-12V | BOMBILLO 2721 T5 12V 1LED BLANCO COB | KTC |
|  | DSA-158-12V | BOMBILLO 158 T10 12V 5W LUZ INTERIOR-LATERALES- | TAIWAN |
| | 204-089 | DELANTERAS-GUANTERA | KTC |
| | 204-090 | BOMBILLO 158 T10 24V 5W LUZ INTERIOR-LATERALES- | KTC |
|  | 322-017W-12V | BOMBILLO 158 T10 12V 1LED BLANCO COB | KTC |
|  | 322-029W-12V | BOMBILLO 158 T10 12V 2LED BLANCO COB SILICONA PEQUEÑO | KTC |
|  | 322-030W-12V | BOMBILLO 158 T10 12V 2LED BLANCO COB SILICONA GRANDE | KTC |
|  | 322-045W-12V | BOMBILLO 158 T10 12V 12LED BLANCO 3030SMD CANBUS NO POLAR | KTC |
| | 158-12V-LED-AZ | BOMBILLO 158-T10 12V CONCAVO 1LED AZUL | TAIWAN |

| | | | |
|---|-----------------|--|--------|
|  | 158-12V-LED-BCO | BOMBILLO 158 T10 1LED 3528 SMD BLANCO CONVEXO | TAIWAN |
|  | 204-112 | BOMBILLO T15 12V 15W LUZ DIRECCIONAL-FRENO-REVERSO GOTERA BOMBA GRANDE | KTC |
| | T15-12V-10W | BOMBILLO T15 12V 10W LUZ DIRECCIONAL-FRENO-REVERSO GOTERA BOMBA GRANDE | TAIWAN |
| | 204-226 | BOMBILLO T15 12V 15W NARANJA LUZ DIRECCIONAL | KTC |
|  | 322-080W-MV | BOMBILLO T15 12V 45LED BLANCO 4014SMD CANBUS NO POLAR MV | KTC |
| | T20-1C | BOMBILLO T20 1C 12V 21W LUZ DIRECCIONAL - FRENO - ANTINIEBLA | TAIWAN |
| | 204-113 | | KTC |
| | 204-138 | BOMBILLO T20 1C 12V 21W NARANJA LUZ DIRECCIONAL | KTC |
|  | 204-114 | BOMBILLO T20 2C 21/5W LUZ DE FRENO - TRASERA ANTINIEBLA NISSAN CARRO JAPONES | KTC |
| | T20-2C | | TAIWAN |
|  | 322-081DW-12V | BOMBILLO T20 12V 48LED BLANCO 2835 SMD CANBUS NO POLAR 2 CONTACTOS | KTC |



| | | | |
|---|----------------|--|--------|
| | 204-084 | BOMBILLO 3157 12V 2C 27/7W LUZ DE FRENO AMERICANOS KENWORTH-FREIGHTLINER | KTC |
| | 3157-12V | | TAIWAN |
| | 204-228 | BOMBILLO 3157 24V 2C 27/7W LUZ DE FRENO AMBAR AMERICANOS-KENWORTH-FREIGHTLINER | KTC |
|  | 3157-12V-AMBAR | BOMBILLO 3157 2C CARRO AME. NARAN | TAIWAN |
|  | 322-052DW-12V | BOMBILLO 3157 12V 2C 20LED BLANCO 5730SMD | KTC |
| | 204-218 | BOMBILLO PSX24W 12V 24W LUZ ANTINEBLA DODGE JOURNEY-CHEROKEE-SPARK GT NEW | KTC |
| | 204-091 | BOMBILLO 10X31 12V 10W SV8.5 LUZ DE TECHO-MALETERO-GUANTERA | KTC |
| | 204-135 | BOMBILLO 11X39 12V 10W LUZ DE TECHO-MALETERO-GUANTERA | KTC |
|  | 322-060-31-12V | BOMBILLO 11X31 12V 10LED BLANCO 4014SMD CANBUS NO POLAR | KTC |
|  | 340-MD-04W-24V | BOMBILLO MODULO 3 LED 3030 BLANCO ABS 360-450 LM 24V | KTC |
| | 204-071 | BOMBILLO P43 12V 35/35W TRICETA HALOGENO ALTAS - BAJAS | KTC |

| | | | |
|--|-----------------|--|--------|
| | P43-12V-60-55W | BOMBILLO P43 12V 60/55W TRICETA HALOGENO ALTAS - BAJAS | TAIWAN |
| | P43-12V-100-90A | BOMBILLO P43 12V 100/90W TRICETA HALÓGENO ALTAS - BAJAS | TAIWAN |
| | 204-KTC035 | | KTC |
| | 204-KTC-043 | BOMBILLO P43 24V 100/90W TRICETA HALOGENO ALTAS - BAJAS | KTC |
| | 204-KTC040- | BOMBILLO P43 12V 60/55W TRICETA XENON ALTAS - BAJAS | KTC |
| | P43-12V-60-55QZ | BOMBILLO P43 12V 60/55W TRICETA XENON ALTAS - BAJAS | TAIWAN |
| | P43-12V-100-9QZ | BOMBILLO P43 12V 100/90W TRICETA XENON ALTAS - BAJAS | TAIWAN |
| | 204-230 | BOMBILLO P43 12V 60/55W +130% MAS LUZ - HIGH TIER LIGHT (SETX2) | KTC |
| | 204-248 | BOMBILLO P43 12V 60/55W+150% MAS LUZ - SUPREME VISION (SETX2) | KTC |
| | 204-KTC027- | BOMBILLO H1 12V 55W ALTA (CLIO) - LUZ DELANTERA - LUZ ANTINEBLA -EXPLORADORA | KTC |
| | H1-12V-55W | | TAIWAN |
| | 204-KTC-025 | BOMBILLO H1 12V 100W ALTA (CLIO) -LUZ DELANTERA - LUZ ANTINEBLA -EXPLORADORA | KTC |
| | H1-12V-100W | | TAIWAN |
| | 204-245 | BOMBILLO H1 12V 55W +130% MAS LUZ - HIGH TIER LIGHT | KTC |

| | | | |
|---|-------------|---|--------|
| | 204-255 | BOMBILLO H1 12V 60/55W +150% MAS LUZ - SUPREME VISION (SETX2) | KTC |
|  | H3-12V-55W | BOMBILLO H3 12V 55W EXPLORADORA | TAIWAN |
| | 204-KTC031 | | KTC |
| | H3-12V-100 | BOMBILLO H3 12V 100W EXPLORADORA | TAIWAN |
| | 204-KTC034 | BOMBILLO H3 24V 70W LUZ DELANTERA - LUZ ANTINIEBLA | KTC |
| | 204-KTC-033 | BOMBILLO H3 24V 100W EXPLORADORA | KTC |
| | H7-12V-55W | BOMBILLO H7 12V 55W MAZDA-CLIO BAJAS | TAIWAN |
| | 204-KTC049- | | KTC |
| | 204-KTC051 | BOMBILLO H7 24V 70W MAZDA-CLIO BAJAS | KTC |
| | 204-KTC-050 | BOMBILLO H7 12V 55W MAZDA/CLIO BAJA LUZ DIA | KTC |
| | 204-229 | BOMBILLO H7 12V 55W +130% MAS LUZ - HIGH TIER LIGHT | KTC |
| | 204-253 | BOMBILLO H7 12V 60/55W +150% MAS LUZ - SUPREME VISION | KTC |
|  | H8-12V-35W | BOMBILLO H8 12V 35W HALÓGENO ANTINIEBLA KIA I10- | TAIWAN |

| | | | |
|---|-------------|---|--------|
|  | 204-KTC147 | SPORTAGE-SAIL | KTC |
| | 204-KTC170 | BOMBILLO H10 12V 42W DODGE RAM-FORD ECOSPORT-EXPLORER-F250-FIESTA | KTC |
| | 204-KTC023 | BOMBILLO H11 12V 55W CAPTIVA-AVEO | KTC |
| | H11-12V-55W | | TAIWAN |
| | H11-12V-100 | BOMBILLO H11 12V 100W CAPTIVA-AVEO | TAIWAN |
| | 204-261 | | KTC |
| | 204-254 | BOMBILLO H11 12V 60/55W +150% MAS LUZ - SUPREME VISION | KTC |
| | 204-KTC169 | BOMBILLO H11 24V 70W | KTC |
|  | 204-241 | BOMBILLO H16 12V <u>24W</u> TOYOTA | KTC |

| | | | |
|---|-------------|---|--------|
| | DSA-880-12V | BOMBILLO 880 12V 27W LUZ DELANTERA ANTINEBLA OPTRA-SPARK-GETZ-TUCSON-TRAILBLAZER | TAIWAN |
| | 204-KTC001 | | KTC |
|  | TAIWAN-881 | BOMBILLO 881 12V 27W HALÓGENO LUZ DELANTERA ANTINEBLA ATOS-SPARK GT | TAIWAN |
| | 204-KTC003- | | KTC |
| | 204-263 | BOMBILLO 889 12V 27W TOYOTA MODELO NUEVO | KTC |
| | 204-264 | BOMBILLO 890 12V 27W HYUNDAI-KIA MODELOS NUEVOS | KTC |
| | 204-267 | BOMBILLO 894 12V 37.5W FAROS ANTINEBLA | KTC |
| | 204-265 | BOMBILLO 896 12V 38W KIA MODELOS NUEVOS | KTC |





| | | | |
|---|-------------|---|-----|
|  | 204-KTC009 | BOMBILLO 9004 12V 60W LUZ DELANtera DAEWOO RACER - FORD RANGER N/M - KIA SPORTAGE - SEPHIA - NISSAN - DODGE RANGER - DAEWOO RACER | KTC |
|  | 204-KTC013 | BOMBILLO 9005 12V 65W LUZ DELANtera CHEVROLET-FORD- TOYOTA CAMIÓNETAS | KTC |
| | 204-KTC011 | BOMBILLO 9005 12V 100W LUZ DELANtera CHEVROLET-FORD-TOYOTA-CAMIÓNETAS | KTC |
| | 204-KTC171 | BOMBILLO 9005XS 12V 65W LUZ DELANtera FREIGHTLINER-KENWORTH M/N | KTC |
| | 204-KTC-017 | BOMBILLO 9006 12V 55W LUZ BAJA BLAZER-FORD FIESTA-ASAHI M/N-CAVALIER M/N | KTC |
| | 204-KTC015 | BOMBILLO 9006 12V 100W LUZ DELANtera AMERICANOS BLAZER-FORD FIESTA-ASAHI M/N-CAVALIER M/N | KTC |

| | | | |
|--|-------------|---|-----|
| | 204-KTC052- | BOMBILLO 9006XS 12V 55W KENWORTH M/N - FREIGHTLINER | KTC |
| | 204-KTC021 | BOMBILLO 9007 12V 65W FORD MODELO NUEVO FORD 150-350 | KTC |
| | 204-270 | BOMBILLO D2R 12V 37W-5500K XENON EXTREME VISION-ALTAS NISSAN XTRAIL-ALTIMA-MAXIMA-R.CLIO-LAGUNA-M.OUTLANDER-VOLVO-MERCE | KTC |
| | 204-222 | BOMBILLO D2S 12V 35W-4300K-XENON BAJAS AUDI-BMW-MAZDA 3-5-6-CX7-CX9-MX5-N.MURANO-MAXIMA-KOLEOS-G.VITARA-V | KTC |
| | 204-236 | BOMBILLO D1R 12V 35W 4300K XENON ALTAS AUDI-BMW-PORSCHE-MERCEDES BENZ-VOLVO | KTC |
| | 204-268 | BOMBILLO D1R 12V 35W-5500K XENON EXTREME VISION-ALTAS AUDI-BMW-PORSCHE-MERCEDES BENZ-VOLVO | KTC |





| | | | |
|--|---------|---|-----|
| | 204-224 | BOMBILLO D2R 12V 37W 4300K XENON ALTAS NISSAN XTRAIL-ALTIMA-MAXIMA-R.CLIO-LAGUNA-M.OUTLANDER-VOLVO-MERCE | KTC |
| | 204-237 | BOMBILLO D4R 12V 35W 4300K XENON ALTAS TOYOTA COROLLA-PREVIA-FORTUNER-LEXUS | KTC |
| | 204-273 | BOMBILLO D4R 12V 35W-5500K XENON EXTREME VISION-ALTAS TOYOTA COROLLA-PREVIA-FORTUNER-LEXUS | KTC |
| | 204-269 | BOMBILLO D1S 12V 35W 5500K XENON EXTREME VISION-BAJAS-AUDI-BMW-MERCEDES BENZ-R.FLUENCE-MEGANE-SCENIC-VOLKSWAGEN-VOLVO | KTC |
| | 204-220 | BOMBILLO D1S 12V 35W 4300K XENON BAJAS-AUDI-BMW-MERCEDES BENZ-R.FLUENCE-MEGANE-SCENIC-VOLKSWAGEN-VOLVO | KTC |
| | 204-222 | BOMBILLO D2S 12V 35W 4300K XENON BAJAS AUDI-BMW-MAZDA 3-5-6-CX7-CX9-MX5-N.MURANO-MAXIMA-KOLEOS-G.VITARA-V | KTC |

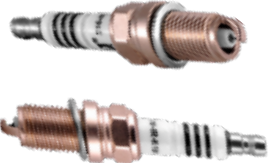



| | | | |
|---|---------|--|--------|
| | 204-221 | BOMBILLO D3S 12V 35W 4300K XENON BAJAS AUDI A4-A5-Q5-FORD EDGE-EXPLORER-ESCAPE-VW JETTA-VOLVO-MERCEDES | KTC |
| | 204-251 | BOMBILLO D8S 12V 25W XENON | KTC |
|  | B-CH-00 | BORNE BATERÍA ZAPATICO COBRE *PEQUEÑO | TAIWAN |
|  | BC | BORNE BATERÍA TIPO CARRETERA COBRE | TAIWAN |
|  | B-CH | BORNE BATERÍA TERMINAL CHAPETA COBRE PARA CABLE *PEQUEÑO | TAIWAN |
|  | B-CH-TP | BORNE BATERÍA TERMINAL CHAPETA TIPO PESADO COBRE | TAIWAN |
| | B-T-P | BORNE BATERÍA TIPO PESADO COBRE | TAIWAN |

| | | | |
|---|---------------|---|--------|
| | B-CH-BR | BORNE BATERÍA TERMINAL TIPO CHAPOLA COBRE | TAIWAN |
|  | TAIWAN-328300 | BORNE BATERIA TIPO CARRETERA *ORIGINAL ROJO-NEGRO | TAIWAN |
|  | DSA-328500 | BORNE BATERIA TIPO CARRETERA ROJO-NEGRO *LUJO 1.2MM 155G COBRE CHAPADO EN HIERRO | TAIWAN |
|  | DSA-993 | CAPUCHON TERMINAL BATERIA NEGRO Y ROJO LARGO 41MM X ANCHO 21MM X ALTO 23MM Y TUBO DE 10MM | TAIWAN |
|  | 02BR000004 | BRAZO PLUMILLA MAZDA 323-MONTERO | TAIWAN |
|  | 02BR000005 | BRAZO PLUMILLA NPR-NKR-NHR | TAIWAN |
|  | 02BR000009 | BRAZO PLUMILLA RENAULT 9-18 | TAIWAN |

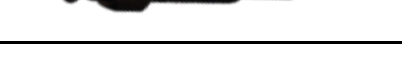
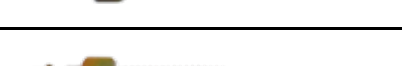
| | | | |
|---|-------------|---|--------|
|  | 02BR000013 | BRAZO PLUMILLA TOYOTA | TAIWAN |
|  | 210-D008 | BUJIA IGNICIÓN***MOTO*** (D8EA) AKT180XM-AK150 EVO-AK125EVO-AK125SL-NKD-HONDA CB450DX-400-XL250R | KTC |
|  | 210-F004 | BUJIA IGNICIÓN (BP5ES) CHRYSLER-FIAT-MITSUBISHI-NISSAN-RENAULT-TOYOTA | KTC |
|  | 210-F005 | BUJIA IGNICIÓN CARBURADOR ROSCA LARGA (BPR5EY) ECOLÓGICA AVEO-SPARK-LUV-VITARA-NISSAN-PEUGEOT-RENAULT | KTC |
|  | 210-F019 | BUJIA IGNICIÓN (BPR5ES) NISSAN-MAZDA B1600/FIAT TEMPRA-UNO/RENAULT R19 | KTC |
|  | 210-IR-K101 | BUJIA IGNICIÓN IRIDIO (BKR5EIX) HYUNDAI-RENAULT-MAZDA-NISSAN-KIA-TOYOTA-AUDI-VW-MERCEDES | KTC |

| | | | |
|---|-------------|--|-----|
|  | 210-K001 | BUJIA IGNICIÓN (BKR5E) LOGAN-TWINGO-CLIO-KANGOO-ESTEEM-MAZDA 323-ATOS-ACCENT | KTC |
|  | 210-K002 | BUJIA IGNICIÓN (BKR5E-11) ATOS-ACCENT-GETZ-I30-PICANTO-CRV-MAZDA-TOYOTA | KTC |
|  | 210-K017 | BUJIA IGNICIÓN (BKR6E-11) AVEO OPTRA-DODGE-HYUNDAI-KIA-MAZDA-SUBARU-TOYOTA-FIAT SIENA STRAD | KTC |
|  | 210-K201-2E | BUJIA IGNICIÓN (BKR5EK) 2 ELECTRODOS CAPTIVA SPORT-GRAND VITARA-OPTRA-VIVANT-XSARA-P306-405-KANGOO | KTC |
| | 210-L030 | BUJIA IGNICIÓN (BM6A) GUADAÑAS-MOTOSIERRAS-CUATRICICLOS | KTC |
|  | 210-LD001 | BUJIA IGNICIÓN (LZKAR7A) KIA PICANTO ION-NISSAN VERSA M-N-CLIO 16V-TWINGO 16V | KTC |
|  | 205-PI173 | BUJIA PRECALENTAMIENTO 24V NHR-NKR-NQR-NPR REWARD 2010/-JAC | KTC |

| | | | |
|--|-----------|---|-----|
|  | 205-PI42 | BUJIA PRECALENTAMIENTO 12V CHEVROLET C220-C240-ELF250 (10.5V) - NPR 97-99 - NKR | KTC |
|  | 205-PI49 | BUJIA PRECALENTAMIENTO 12V NKR-NHR-FVR 4JB1-4JA1 - DMAX KB /2005 (11V) | KTC |
|  | 205-PN135 | BUJIA PRECALENTAMIENTO 12V NISSAN TD25-TD27-TD42 N.P.U. 87-99-MT3000-DAIHATSU (11V) | KTC |
|  | 205-PM75 | BUJIA PRECALENTAMIENTO 12V HYUNDAI H100-H1 STAREX-PAJERO 4D55-4D55T-4D56-4D56T 82-90 | KTC |
|  | 205-PT104 | BUJIA PRECALENTAMIENTO 12V DAIHATSU DELTA DG-DL-B-3B - TOYOTA DYNA 2J-B-2B-DG (8.5V) | KTC |
|  | 205-PT151 | BUJIA PRECALENTAMIENTO 12V TOYOTA HILUX-LAND CRUISER-PRADO-COROLLA-HIACE TRUCK (11V) | KTC |
|  | 205-PT157 | BUJIA PRECALENTAMIENTO 12V TOYOTA PRADO- VIGO 3.0- FORTUNER-HILUX-LAND CRUISER-RAV4-YARIS (11V) (19850-27010) | KTC |
|  | 205-PZ30 | BUJIA PRECALENTAMIENTO 12V NPR-MAZDA BONGO E3000 -KIA CERES(12V) | KTC |
|  | 205-PZ31 | BUJIA PRECALENTAMIENTO 24V MAZDA T45 TITAN ZB-XA - KIA 2.2 (23V) | KTC |
|  | 205-PZ33 | BUJIA PRECALENTAMIENTO 12V NPR-MAZDA BONGO RF-R2-TELSTAR-SPECTRON-J80-KIA (10.5V) | KTC |
|  | 205-PZ38 | BUJIA PRECALENTAMIENTO 12V KIA BESTA-SPORTAGE (03-08)-RETONA (99-06)-TOPIC-MAZDA B-MPV (11V) | KTC |
|  | 205-PZ39 | BUJIA PRECALENTAMIENTO 12V MAZDA BT50-KIA PREGIO 97-10-BESTA 96-02-SPORTAGE 97-10-FORD RANGER-MPV-62 | KTC |

| | | | |
|--|-----------------|---|-------------|
|  | 205-PZ710 | BUJIA PRECALENTAMIENTO 12V MAZDA BT50 - FORD RANGER 3 TDCi 4X4 05- | KTC |
|  | BATERIA-N6 | CABLE BATERÍA #6 SOLDADOR COBRE | CONALCABLES |
| | BATERIA-N4 | CABLE BATERÍA #4 SOLDADOR COBRE | CONALCABLES |
| | 246-4 | CABLE BATERIA #4 (EPDM RUBBER) 600V.(Roll X 50mts)-(164.042 ft)-(54.6807 vd) NEGRO | KTC |
| | BATERIA-N2 | CABLE BATERÍA #2 SOLDADOR COBRE | CONALCABLES |
| | 246-2 | CABLE BATERIA #2 (EPDM RUBBER) 600V.(Roll X 50mts)-(164.042 ft)-(54.6807 vd) NEGRO | KTC |
| | SOLDADOR-1-0 | CABLE BATERÍA #1/0 SOLDADOR COBRE | CONALCABLES |
|  | 246-1.0 | CABLE BATERIA #1/0 (EPDM RUBBER) 600V. (Roll X 50mts)-(164.042 ft)-(54.6807 vd) NEGRO | KTC |
| | 3FBU118NRJ | CABLE DE ALTA ALAMBRE 7MM NARANJA | INDUCABLES |
| | 3FBU118NG | CABLE DE ALTA ALAMBRE 7MM NEGRO | INDUCABLES |
| | C7MM-N | CABLE DE ALTA ALAMBRE 7MM NARANJA | NACIONAL |
|  | C7MM | CABLE DE ALTA ALAMBRE 7MM NEGRO | NACIONAL |
| | TAIWAN-169023-5 | CABLE DESVARE 1200 AMP x 5MTS ROJO - NEGRO | TAIWAN |
|  | TAIWAN-69023 | CABLE DESVARE 1200AMP x 2.5MTS ROJO - NEGRO | TAIWAN |
| | DSA-17344 | CABLE DESVARE 500AMP x 2.5MTS ROJO - NEGRO | TAIWAN |

| | | | |
|---|--------------|--|------------|
|  | DSA-14531-5 | CABLE DESVARE 500AMP x 5MTS ROJO - NEGRO | TAIWAN |
|  | JUC-63560 | CABLE DESVARE 600AMP x 2.5MTS ROJO - NEGRO | TAIWAN |
| | DSA-14531-6 | CABLE DESVARE 600AMP x 5MTS ROJO - NEGRO | TAIWAN |
| | 335641 | CABLE DUPLEX 2X22 POLARIZADO NEGRO-ROJO | INDUCABLES |
|  | 246-HY-10-BL | CABLE VEHICULAR No.10 NEGRO (ROLLO 100m - 328ft) - 55/0.30mm | KTC |
|  | 246-HY-16-R | CABLE VEHICULAR No. 16 ROJO (ROLLO 100m - 328ft) - 27/0.20mm | KTC |
|  | 246-HY-16-Y | CABLE VEHICULAR No. 16 AMARILLO (ROLLO 100m - 328ft) - 27/0.20mm | KTC |

| | | | |
|---|--------------|--|----------------|
|  | 246-HY-18-BL | CABLE VEHICULAR No.18 NEGRO (ROLLO 100m - 328ft) - 18/0.20mm | KTC |
|  | 246-HY-18-R | CABLE VEHICULAR No.18 ROJO (ROLLO 100m - 328ft) - 18/0.20mm | KTC |
|  | 246-HY-20-R | CABLE VEHICULAR No.20 ROJO (ROLLO 100m - 328ft) - 11/0.20mm | KTC |
|  | C-8-N | CABLE INSTALACIÓN VEHICULAR NORMA #8 COLORES | INDUCIBLE S |
| | C-12-N | CABLE INSTALACIÓN VEHICULAR NORMA #12 COLORES | INDUCIBLE S |
| | C-14-N | CABLE INSTALACIÓN VEHICULAR NORMA #14 COLORES | INDUCIBLE S |
| | C-16-N | CABLE INSTALACIÓN VEHICULAR NORMA #16 COLORES | INDUCIBLE S |
| | C-18-N | CABLE INSTALACIÓN VEHICULAR NORMA #18 COLORES | INDUCIBLE S |
| | C-20-N | CABLE INSTALACIÓN VEHICULAR NORMA #20 COLORES | INDUCIBLE S |
|  | DSA-490034 | CAIMAN BATERIA MINI ROJO/NEGRO 36MM | TAIWAN |

| | | | |
|---|-------------------|--|---------------|
|  | <p>DSA-490036</p> | <p>CAIMAN BATERIA PEQUEÑO ROJO/NEGRO 54MM</p> | <p>TAIWAN</p> |
|  | <p>DSA-490033</p> | <p>CAIMAN BATERIA MEDIANO ROJO/NEGRO 10AMP 48x21MM (BC3708-B)</p> | <p>TAIWAN</p> |
|  | <p>DSA-490032</p> | <p>CAIMAN BATERIA MEDIANO ROJO/NEGRO 30AMP 95x561MM (LS-A02)</p> | <p>TAIWAN</p> |
|  | <p>49003703</p> | <p>CAIMAN BATERÍA GRANDE ROJO - NEGRO</p> | <p>TAIWAN</p> |
|  | <p>206-001</p> | <p>CAJA PORTAFUSIBLE ELECTRÓNICO 4 PUESTOS SIN CABLE TIPO ALEMÁN</p> | <p>KTC</p> |
|  | <p>206-002</p> | <p>CAJA PORTAFUSIBLE ELECTRÓNICO 6 PUESTOS SIN CABLE TIPO ALEMÁN</p> | <p>KTC</p> |

| | | | |
|---|-----------|---|--------|
|  | 206-003 | CAJA PORTAFUSIBLE ELECTRÓNICO 8 PUESTOS SIN CABLE TIPO ALEMÁN | KTC |
|  | 206-004 | CAJA PORTAFUSIBLE ELECTRÓNICO 10 PUESTOS SIN CABLE TIPO ALEMÁN | KTC |
|  | 206-006 | CAJA <u>PORTAFUSIBLE ELECTRÓNICO MINI</u> 6 PUESTOS SIN CABLE TIPO ALEMÁN | KTC |
|  | 9000702-S | CAJA PORTAFUSIBLE ELECTRÓNICO 6 PUESTOS SIN CABLE | TAIWAN |
|  | 9000501-S | CAJA PORTAFUSIBLE ELECTRÓNICO 8 PUESTOS SIN CABLE | TAIWAN |
|  | 9000102-S | CAJA PORTAFUSIBLE ELECTRÓNICO 10 PUESTOS SIN CABLE | TAIWAN |

| | | | |
|---|--------------|--|---------------|
|  | SQ-803-SC | CAJA PORTAFUSIBLE ELECTRÓNICO 12 PUESTOS SIN CABLE | TAIWAN |
|  | SQ-803-ELC | CAJA PORTAFUSIBLE ELECTRÓNICO 10 PUESTOS SIN CABLE *TAPA TRANSPARENTE | TAIWAN |
|  | TAIWAN-787 | CAJA PORTAFUSIBLE ELECTRÓNICO 6 PUESTOS CON CABLE | TAIWAN |
| | SQ-788 | CAJA PORTAFUSIBLE ELECTRÓNICO 8 PUESTOS CON CABLE | TAIWAN |
| | DSA-SQ789 | CAJA PORTAFUSIBLE ELECTRÓNICO 10 PUESTOS CON CABLE | TAIWAN |
| | SQ-803 | CAJA PORTAFUSIBLE ELECTRÓNICO 12 PUESTOS CON CABLE | TAIWAN |
|  | TAIWAN-21312 | CHICLER ELECTRÓNICO TOYOTA - SUZUKI | TAIWAN |
|  | MG-02-12029 | CILINDRO/CHAPA PUERTA MAZDA 323 *CON LLAVE (BE32-76-210/220 - BO32-76-210/220) | GENUINE PARTS |
|  | MG-02-02030 | CILINDRO/CHAPA PUERTA RENAULT 9-11 CON LLAVE (7700795759) | GENUINE PARTS |

| | | | |
|---|-------------|---|---------------|
|  | MG-02-02039 | CILINDRO/CHAPA PUERTA RENAULT 9 CON LLAVE | GENUINE PARTS |
|  | MG-02-02040 | CILINDRO/CHAPA BAÚL RENAULT 9 CON LLAVE | GENUINE PARTS |
|  | MG-02-02041 | CILINDRO/CHAPA BAÚL RENAULT 9 CON LLAVE | GENUINE PARTS |
|  | MG-02-02046 | CILINDRO/CHAPA PUERTA RENAULT MEGANE - SCENIC *CON LLAVE (7701468981 LH7701468982 RH) | GENUINE PARTS |
|  | MG-02-02047 | CILINDRO/CHAPA PUERTA RENAULT CLIO II - MEGANE *CON LLAVE (7701472806) | GENUINE PARTS |
|  | MG-02-02077 | CILINDRO/CHAPA BAÚL RENAULT LOGAN - CLIO *CON LLAVE (7700431773 7701472508) | GENUINE PARTS |
|  | MG-04-01499 | CHAPA BAÚL RENAULT LOGAN - CLIO - TWINGO (7700791731) | GENUINE PARTS |

| | | | |
|---|--------------------|---|--------------------------|
|  | <p>MG-02-02056</p> | <p>CILINDRO/CHAPA BAÚL RENAULT CLIO *CON LLAVE (7701471225)</p> | <p>GENUINE PARTS</p> |
|  | <p>MG-10-01308</p> | <p>CHAPA BAÚL RENAULT CLIO (7700434689 - 7700817724 - 6001544157)</p> | <p>GENUINE PARTS</p> |
|  | <p>MG-02-02066</p> | <p>CILINDRO/CHAPA PUERTA RENAULT LOGAN</p> | <p>GENUINE PARTS</p> |
|  | <p>MG-02-02079</p> | <p>CILINDRO/CHAPA BAÚL RENAULT LOGAN (7701367940)</p> | <p>GENUINE PARTS</p> |
|  | <p>MG-02-02069</p> | <p>CILINDRO/CHAPA BAÚL RENAULT SANDERO</p> | <p>GENUINE PARTS</p> |
|  | <p>MG-02-02083</p> | <p>CILINDRO/CHAPA BAÚL RENAULT DUSTER 10-18 *4 PINES (905026966R)</p> | <p>GENUINE PARTS</p> |





| | | | |
|---|--------------------|---|----------------------|
|  | <p>MG-02-02084</p> | <p>CILINDRO/CHAPA BAÚL RENAULT DUSTER 10-18</p> | <p>GENUINE PARTS</p> |
|  | <p>MG-02-02074</p> | <p>CILINDRO/CHAPA PUERTA RENAULT DUSTER - - SANDERO (6001550787*) *LLAVES PLÁSTICAS</p> | <p>GENUINE PARTS</p> |
|  | <p>MG-02-02071</p> | <p>CILINDRO/CHAPA BAÚL RENAULT LOGAN (905020198R)</p> | <p>GENUINE PARTS</p> |
|  | <p>MG-02-02029</p> | <p>CILINDRO/CHAPA PUERTA RENAULT KANGOO (5PCS/SET)</p> | <p>GENUINE PARTS</p> |
|  | <p>MG-02-07012</p> | <p>CILINDRO/CHAPA PUERTA DAEWOO MATIZ (S60460026)</p> | <p>GENUINE PARTS</p> |

| | | | |
|---|--------------------|--|----------------------|
|  | <p>MG-02-07046</p> | <p>CILINDRO/CHAPA PUERTA Y BAÚL KIA PICANTO</p> | <p>GENUINE PARTS</p> |
|  | <p>MG-02-07049</p> | <p>CILINDRO/CHAPA PUERTA Y BAÚL KIA PICANTO</p> | <p>GENUINE PARTS</p> |
|  | <p>MG-02-07053</p> | <p>CILINDRO/CHAPA PUERTA Y BAÚL KIA PICANTO - HYUNDAI ELANTRA</p> | <p>GENUINE PARTS</p> |
|  | <p>MG-02-07025</p> | <p>CILINDRO/CHAPA PUERTA HYUNDAI ATOS (8198002A00 RH8197002A00 LH)</p> | <p>GENUINE PARTS</p> |

| | | | |
|---|--------------------|--|----------------------|
|  | <p>MG-02-07048</p> | <p>CILINDRO/CHAPA PUERTA KIA PICANTO</p> | <p>GENUINE PARTS</p> |
|  | <p>MG-02-13023</p> | <p>CILINDRO/CHAPA PUERTA CHEVEROLET D-MAX (897376589/90 - 897236071/2)</p> | <p>GENUINE PARTS</p> |
|  | <p>MG-02-09058</p> | <p>CILINDRO/CHAPA PUERTA TOYOTA LAND CRUISER FJ45/50 78-83 JUEGOX2 (6905169015 - 6905269015)</p> | <p>GENUINE PARTS</p> |
|  | <p>MG-02-09060</p> | <p>CILINDRO/CHAPA PUERTA TOYOTA HILUX RN80 (6905135030 - 6905235030)</p> | <p>GENUINE PARTS</p> |

| | | | |
|---|--------------------|---|----------------------|
|  | <p>MG-02-13026</p> | <p>CILINDRO/CHAPA PUERTA ISUZU - DMAX (8-98193736/7)</p> | <p>GENUINE PARTS</p> |
|  | <p>MG-04-01437</p> | <p>BISAGRA PUERTA</p> | <p>GENUINE PARTS</p> |
|  | <p>207-001</p> | <p>CINTA AISLANTE ELÉCTRICA EN PVC NEGRA ROLLO GRANDE 20YD - 60FT</p> | <p>KTC</p> |
|  | <p>207-002</p> | <p>CINTA AISLANTE ELÉCTRICA EN PVC NEGRA ROLLO PEQUEÑO 10YD 30FT</p> | <p>KTC</p> |
|  | <p>325-003</p> | <p>CINTA RETROREFLECTIVA ROJO 279mm.(11in) X BLANCO 178mm.(7in)51mm.(2in)wide trimDOT-C2NTC5807 1PC</p> | <p>KTC</p> |

| | | | |
|---|---------------|---|--------|
|  | 320-3691 | CONECTOR LED STOP 2P LAMPARA AMERICANA DEMARCADORA | KTC |
|  | 32053102-12DS | CONECTOR LED STOP 3P LAMPARA AMERICANA STOP Y DIRECCIONAL | TAIWAN |
| | 320-53102-12V | | KTC |
| | 200-750P | CONECTOR TRAILER MACHO 7 VIAS RESORTE | KTC |
|  | DSA-750PLUG | CONECTOR TRAILER MACHO 7 VIAS RESORTE | TAIWAN |
|  | 200-750S | CONECTOR TRAILER HEMBRA 7 VIAS TAPA | KTC |

| | | | |
|---|---------------|---|--------|
|  | DSA-750SOCKET | CONECTOR TRAILER HEMBRA 7 VIAS TAPA | TAIWAN |
|  | 111-155 | CONECTOR TRAILER CABLE 7 VIAS NEGRO 15 PIES (4,57 m) INCLUYE CONECTORES (6 CALIBRE 14) (CABLE BLANCO CALIBRE 12 | KTC |
| | 1-A | CORAZA 1/2 PULGADA ABIERTA ROLLO X 25MTS | TAIWAN |
| | 1.2-A | CORAZA 1/2 PULGADA ABIERTA ROLLO X 25MTS | TAIWAN |
| | 1.4-A | CORAZA 1/4 PULGADA ABIERTA ROLLO X 25MTS | TAIWAN |
| | 3.16-A | CORAZA 3/16 PULGADA ABIERTA ROLLO X 25MTS | TAIWAN |
| | 3.4-A | CORAZA 3/4 PULGADA ABIERTA ROLLO X 25MTS | TAIWAN |
| | 3.8-A | CORAZA 3/8 PULGADA ABIERTA ROLLO X 25MTS | TAIWAN |
| | 5.8-A | CORAZA 5/8 PULGADA ABIERTA ROLLO X 25MTS | TAIWAN |
| | TAIWAN-5.16-A | CORAZA 5/16 PULGADA ABIERTA ROLLO X 25MTS | TAIWAN |
|  | TAIWAN-9101 | CORNETA DOBLE 232*295mm CON VÁLVULA 12V-24V 1PC | TAIWAN |
| | 309-101 | | KTC |
|  | 309-102 | CORNETA TRIPLE 125*190*255mm CON VÁLVULA 12V/24V 1PC | KTC |
| | DSA-6701 | CORREILLA PLÁSTICA 100X3.6mm NEGRA | TAIWAN |

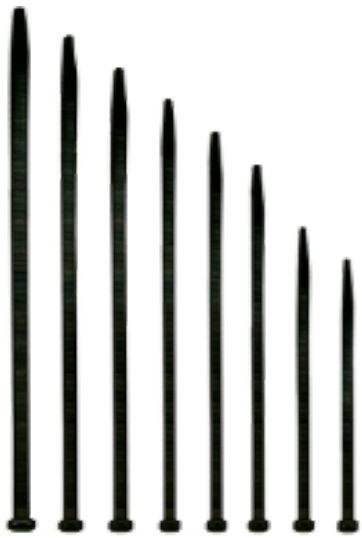

| | | |
|--------------|------------------------------------|--------|
| 2.5X102BLACK | CORREILLA PLÁSTICA 102X2.5mm NEGRA | TAIWAN |
| 247-007K | CORREILLA PLÁSTICA 150x3.3mm NEGRA | KTC |
| 3.6X150BLACK | CORREILLA PLÁSTICA 150X3.6mm NEGRA | TAIWAN |
| DSA-6704 | CORREILLA PLÁSTICA 200x2.5mm NEGRA | TAIWAN |
| DSA-6705 | CORREILLA PLÁSTICA 200X3.6mm NEGRA | TAIWAN |
| DSA-6706 | CORREILLA PLÁSTICA 200X4.8mm NEGRA | TAIWAN |
| 247-008K | CORREILLA PLÁSTICA 204x3.6mm NEGRA | KTC |
| DSA-6707 | CORREILLA PLÁSTICA 204X3.6mm NEGRA | TAIWAN |
| 247-010K | CORREILLA PLÁSTICA 247x3.6mm NEGRA | KTC |
| DSA-6708 | CORREILLA PLÁSTICA 250x4.8mm NEGRA | TAIWAN |
| ALN-35 | CORREILLA PLÁSTICA 300X3.6mm NEGRA | TAIWAN |
| DSA-6710 | CORREILLA PLÁSTICA 300X4.8mm NEGRA | TAIWAN |
| 247-012K | CORREILLA PLÁSTICA 302x4.8mm NEGRA | KTC |
| DSA-6711 | CORREILLA PLÁSTICA 350X4.8mm NEGRA | TAIWAN |
| DSA-6712 | CORREILLA PLÁSTICA 350X7.8mm NEGRA | TAIWAN |
| 247-013K | CORREILLA PLÁSTICA 368x4.8mm NEGRA | KTC |
| 247-015K | CORREILLA PLASTICA 368x7.6mm NEGRA | KTC |
| DSA-6713 | CORREILLA PLÁSTICA 400X4.8mm NEGRA | TAIWAN |
| 247-014K | CORREILLA PLÁSTICA 428x4.8mm NEGRA | KTC |
| 428X4.8BLACK | CORREILLA PLÁSTICA 428X4.8mm NEGRA | TAIWAN |
| 4.8X450BLACK | CORREILLA PLASTICA 450X4.8mm NEGRA | TAIWAN |
| 247-016K | CORREILLA PLÁSTICA 450x7.6mm NEGRA | KTC |
| 7.8X450BLACK | CORREILLA PLASTICA 450X7.8MM NEGRA | TAIWAN |
| 247-017K | CORREILLA PLASTICA 540x7.6mm NEGRA | KTC |
| 7.8X550BLACK | CORREILLA PLASTICA 550X7.8MM NEGRA | TAIWAN |
| 247-018K | CORREILLA PLASTICA 702x9.0mm NEGRA | KTC |







| | | |
|--------------|----------------------------|--------|
| TAIWAN-521HD | CRUCETA CARDÁN JEEP WILLYS | TAIWAN |
|--------------|----------------------------|--------|











| | | |
|---------|-----------------------------|--------|
| ST-1538 | CRUCETA CARDÁN SUZUKI SJ410 | TAIWAN |
|---------|-----------------------------|--------|

| | | | |
|---|--------------|--|--------|
|  | ST-1639 | CRUCETA CARDÁN LUV 1600 - 2300 / TROOPER (16 x 39mm) | TAIWAN |
|  | TAIWAN-1640 | CRUCETA CARDÁN LUV 2300 / TROPER / NPR (16MMX40MM) | TAIWAN |
|  | TAIWAN-J5188 | CRUCETA DE CARDÁN FORD CARGO 815/ F750 / CHEVROLET C70 351 / B600 DIESEL / FORD F600 PIR (5-188X) GU-2300 | TAIWAN |
|  | JS-160 | CRUCETA DE CARDÁN NPR 97 / NKR / TRITON /S.DUTY /ENCAVA /DODGE 300 75/81 CUSTOM F-5006/00 65/78 C10 C30 80/87 P30- DINA IVECO PE 5-160X (G5-160X) (30.2X106) | TAIWAN |
|  | J5-170 | CRUCETA CARDÁN D-100/300/600 - JEEP CJ6 UNIVERSAL VOLVO PI (23.8X34.8X60) | TAIWAN |

| | | | |
|--|----------------------|---|---------------|
|  | <p>TAIWAN-J5178X</p> | <p>CRUCETA DE CARDÁN F350 F6 48/56 - CHEV.3800 48/55 C10/30 P30 - NISSAN PATROL DEL. (J5-178) PE (30.2X92)</p> | <p>TAIWAN</p> |
|  | <p>DSA-5-213</p> | <p>CRUCETA DE CARDÁN TOYOTA 4.5 VIGO</p> | <p>TAIWAN</p> |
|  | <p>GU-500</p> | <p>CRUCETA DE CARDÁN LADA TODOS / LUV 1600 DODGE 1500 / WFR4ZC1 / SIMCA / FIAT C/GRAS PE (LARGO 49.2MM DIAMETRO EXTERIOR 154.9MM) (23.8X62)</p> | <p>TAIWAN</p> |
|  | <p>GU-700</p> | <p>CRUCETA DE CARDÁN CHEVETTE / B2000 /LUV 4X4 DEL- TRASERA.(437)</p> | <p>TAIWAN</p> |
|  | <p>DSA-GUD81</p> | <p>CRUCETA CARDÁN NISSAN-INFINITI-SUBARU-SUZUKI 27x81.75/20CR *8482109000</p> | <p>TAIWAN</p> |

| | | | |
|---|----------------------|--|---------------|
|  | <p>GUD-84</p> | <p>CRUCETA DE CARDÁN DAIHATSU F20 F50 (28X80) DAIHATSU F10 F20 77/ =TD184 PE</p> | <p>TAIWAN</p> |
|  | <p>GUS-1</p> | <p>CRUCETA DE CARDÁN SUZUKI LJ50-LJ80-SJ410/ SUBARU/ NISSAN GRAS EN DADO PI (25X402X63)</p> | <p>TAIWAN</p> |
|  | <p>TAIWAN-GUIS52</p> | <p>CRUCETA DE CARDÁN CHEVROLET LUV 2300 4X4 NKR DELANTERA CHEVROLET TROOPER 2.3L 1983-1992 (383) (29X50X76)</p> | <p>TAIWAN</p> |
|  | <p>GUM-81</p> | <p>CRUCETA DE CARDÁN ORIGINAL PARA CHEVROLET N200 - N300 / MITSUBISHI L300 4G54 / MONTERO 88/94 / SJ413 / CARROS CHINOS PEQ PE (25X63.8)</p> | <p>TAIWAN</p> |
|  | <p>DSA-GUN29</p> | <p>CRUCETA DE CARDÁN TOYOTA HIACE III-KASTEN H50 2.4L 1989-1995 (39625-21005)</p> | <p>TAIWAN</p> |

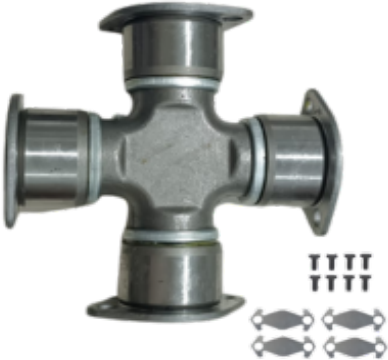
| | | | |
|---|---------------------|--|---------------|
|  | <p>DSA-GUN30</p> | <p>CRUCETA DE CARDÁN NISSAN /79</p> | <p>TAIWAN</p> |
|  | <p>TAIWAN-GUN46</p> | <p>CRUCETA DE CARDÁN NISSAN PATHFINDER URVAN/VANETTE / KIA TRAS. PI (27X46X71)</p> | <p>TAIWAN</p> |
|  | <p>GUT-20</p> | <p>CRUCETA DE CARDÁN TOYOTA HILUX 75/80 LAND CRUISER 69-80 2F FJ40-FJ45 KIA BESTA 04371-36020 PI (32X61X91.6)</p> | <p>TAIWAN</p> |
|  | <p>DSA-GUT21</p> | <p>CRUCETA DE CARDÁN TOYOTA DIAMETRO 29MM - LONGITUD 49MM *GUT-21 *04371-35020</p> | <p>TAIWAN</p> |
|  | <p>DSA-GUT23</p> | <p>CRUCETA DE CARDÁN TOYOTA-ISUZU-OPEL-JAC 1041 DIAMETRO 29MM - LONGITUD 77MM *GUT-23 *04371- 35050 *04371-60100</p> | <p>TAIWAN</p> |

| | | | |
|--|-------------------|---|---------------|
|  | <p>DSA-GUT-25</p> | <p>CRUCETA DE CARDÁN D-MAX 4X4 MZ-BT50 4X4 HILUX.VIGO LONGITUD 81.8MM X DIAMETRO 27MM - CGGUT25</p> | <p>TAIWAN</p> |
|  | <p>TAIWAN-333</p> | <p>CRUCETA DE CARDÁN UNIVERSAL 333 DIAMETRO 47.62MM LONGITUD 134.9MM *5-279X</p> | <p>TAIWAN</p> |
|  | <p>DSA-334</p> | <p>CRUCETA DE CARDÁN UNIVERSAL 334 DIAMETRO 49.2MM- LONGITUD 154.9MM *5-280X *GU-5000</p> | <p>TAIWAN</p> |

| | | | |
|---|---------------------|---|---------------|
|  | <p>DSA-GUAZ3</p> | <p>CRUCETA DE CARDÁN MOTOCARRO 22X54</p> | <p>TAIWAN</p> |
|  | <p>231-008</p> | <p>CUCHILLA BATERÍA MINI 12-32V - 100AMP (MAXIMO AWG2)</p> | <p>KTC</p> |
|  | <p>TAIWAN-31010</p> | <p>CUCHILLA MASTER BATERÍA METÁLICO (SUBIR Y BAJAR CARPAS DE CAMIONES) (52-800)</p> | <p>TAIWAN</p> |
| | <p>231-010</p> | | <p>KTC</p> |
|  | <p>231-SM</p> | <p>CUCHILLA MASTER BATERÍA METÁLICO 12-24V - 75AMP 2C TIPO PESADO</p> | <p>KTC</p> |
| | <p>BT-001</p> | | <p>TAIWAN</p> |
|  | <p>DSA-31005</p> | <p>CUCHILLA MASTER BATERÍA 12-24V - 180AMP - 4 TORNILLOS TIPO POLLAK</p> | <p>TAIWAN</p> |

| | | | |
|---|---------------|---|---------------|
|  | 231-005 | CUCHILLA MASTER BATERÍA 12-24V - 180AMP - 4 TORNILLOS TIPO POLLAK | KTC |
|  | TAIWAN-31004 | CUCHILLA MASTER BATERÍA 6-36V - 190AMP - 2 TORNILLOS TIPO POLLAK | TAIWAN |
| | 231-004 | | KTC |
| | MG-02-16009 | | GENUINE PARTS |
| | 8481808-DS | | TAIWAN |
|  | 226-001 | ELEVADOR LUCES 4P 12V 40AMP UNIVERSAL CAJA X 25UND | KTC |
| | DSA-26001 | | TAIWAN |
|  | 226-036 | ELEVADOR LUCES 4P 12V 40AMP UNIVERSAL CON RESISTENCIA | KTC |
|  | 226-005 | ELEVADOR LUCES 4P 12V 80AMP TIPO PESADO | KTC |
| | TAIWAN-226005 | | TAIWAN |
|  | 226-002 | ELEVADOR LUCES 4P 24V 40AMP | KTC |
| | 226-002E | | TAIWAN |

| | | | |
|---|-----------------|---|--------|
|  | TAIWAN-26002 | | TAIWAN |
|  | 226-003-E | ELEVADOR LUCES 5P 12V 30/40AMP CONMUTABLE | GPM |
| | 226-003 | | KTC |
| | 226003-DS | | TAIWAN |
|  | 226-037 | ELEVADOR LUCES 5P 12V 30/40AMP CON RESISTENCIA | KTC |
| | TAIWAN-26037 | | TAIWAN |
|  | TRANSP-REALLY-L | ELEVADOR LUCES 5P 12V 80AMP TIPO PESADO LED | TAIWAN |
| | TRANSP-REAL-24V | ELEVADOR LUCES 5P 24V 80AMP TIPO PESADO LED | TAIWAN |
|  | DSA-26032 | ELEVADOR LUCES 5P 12V 30/40AMP LED INDICADOR-RESISTENTE AL AGUA | TAIWAN |
| | 226-032 | | KTC |
| | 226-032-E | | GPM |
|  | TAIWAN-26027 | ELEVADOR LUCES 5P 12V TIPO PESADO 60/80 AMP | TAIWAN |
| | 226-027 | | KTC |

| | | | |
|---|---------------|--|--------|
|  <p>The image shows a blue KTC relay with a wiring diagram. The diagram labels terminals 30, 86, 85, 87, and 87a. The relay has two gold-colored terminals on the bottom.</p> | 226-004 | ELEVADOR LUCES 5P 24V 20/30AMP UNIVERSAL | KTC |
| | TAIWAN-26004 | | TAIWAN |
|  <p>The image shows a black relay labeled '12V RELAY 12193804' with a wiring diagram. The diagram labels terminals 85, 87, 86, and 30. The relay has two silver-colored terminals on the bottom.</p> | 226-031 | ELEVADOR LUCES AGUJA MINI 4P 12V AVEO-OPTRA-CORSA-CHEYENNE-CAPTIVA-EPICA-IMPALA-DAEWOO BOMBA GAS-VIDRIOS-A/A-ECM | KTC |
| | VB01-041-4P | | TAIWAN |
|  <p>The image shows a black relay labeled 'RELAY 12V 20A' with a wiring diagram. The diagram labels terminals 85, 87, 86, and 30. The relay has two silver-colored terminals on the bottom.</p> | 226-030 | ELEVADOR LUCES AGUJA MINI 5P 12V CHEVROLET 94-98-TRUCK 95-98-GMC TRUCK 95--BUICK 94-98 | KTC |
| | 226-030-E | | GPM |
| | TAIWAN-041-5P | | TAIWAN |
|  <p>The image shows a black relay labeled 'RELAY 12V 4P 95220-38000' with a wiring diagram. The diagram labels terminals 30, 86, 85, and 87. The relay has two silver-colored terminals on the bottom.</p> | DSA-26029 | ELEVADOR LUCES AGUJA MINI 4P 12V 25A AVEO-OPTRA-GM BOMBA-IGNICIÓN-A/A | TAIWAN |
| | 226-029 | | KTC |
|  <p>The image shows a black relay labeled '12V 30A' with a wiring diagram. The diagram labels terminals (30)0, (87)0, (86)0, and (85)0. The relay has two silver-colored terminals on the bottom.</p> | 226-015-E | ELEVADOR LUCES MINI 4P 12V 30A MINI M/N TOYOTA YARIS-LAND CRUISER-4RUNNER-GMC TRUCK GPM | GPM |
| | 226-015 | | KTC |

| | | | |
|---|--------------|---|--------|
|  | 226-016 | ELEVADOR LUCES MINI 5P 12V 30A CHEVROLET 91-95-TRUCK 92-98-KOREAN CARS-TOYOTA RAV4 08-12-YARIS 05-08-LAND CRUISER | KTC |
| | 226-016E | | GPM |
| | TAIWAN-26016 | | TAIWAN |
|  | TAIWAN-26038 | ELEVADOR LUCES MINI 5P 12V 30AMP | TAIWAN |
|  | DSA-26049 | ELEVADOR LUCES MINI 4P 24V UNIVERSAL | TAIWAN |
| | 226-049 | | KTC |
| | 226-049-E | | GPM |
|  | 226-017 | ELEVADOR LUCES MINI 5P 24V MODELO NUEVO UNIVERSAL | KTC |
| | 226-017-E | | GPM |
| | TAIWAN-26017 | | TAIWAN |

| | | | |
|---|------------|--|--------|
|  | 226-019-E | ELEVADOR LUCES 3P 12V TOYOTA MULTIUSO 22A - LAND CRUISER-T100-4RUNNER | KTC |
|  | 226-020 | ELEVADOR LUCES 5P 12V CHEVROLET AVEO-BLAZER-CRUZE-SILVERADO-GMC TRUCKS A/A-ACCESORY SAFETY-COMPUTABLEROCONTR | KTC |
| | 226-020-2E | | GPM |
|  | 226-042 | ELEVADOR LUCES 4P 12V DMAX 06-15- TOYOTA LAND CRUISER 98-10-4RUNNER 96-11-RAV4 01-07-COROLLA 98-07-YARIS-CAMRY | KTC |
|  | 226-035-E | ELEVADOR ENCENDIDO 5P 12V PRECALENTAMIENTO NPR-NKR M/N (8971739510) | GPM |
| | 226-044-E | ELEVADOR ENCENDIDO 5P 24V PRECALENTAMIENTO NPR-NQR-FRR REWARD | GPM |
| | DSA-26044 | | TAIWAN |
|  | 226-047-E | ELEVADOR ENCENDIDO 12V 4P JAC - CHEVROLET NPR 4BD1 | GPM |

| | | | |
|---|----------|---|--------|
|  | 226-051 | ELEVADOR MOTOVENTILADOR 4P 12V MAZDA 323 89-98-626-929-B-SERIES (H30067740) | GPM |
|  | DSA-134 | EMBOLO AUTOMÁTICO NIPPONDENSO NPR- NISSAN 180 (119mmx39.8mm) (66-82606) | TAIWAN |
| | 201-34- | | KTC |
|  | DSA-0133 | EMBOLO AUTOMÁTICO NIPPONDENSO (119mmx39.8mm) (66-82605) | TAIWAN |
| | 201-33 | | KTC |
|  | DSA-132 | EMBOLO AUTOMÁTICO NIPPONDENSO (95.5mmx36.8mm) (66-82600) | TAIWAN |
| | 201-32 | | KTC |
|  | DSA-137 | EMBOLO AUTOMÁTICO NIPPONDENSO 1.0kW 1.2kW 1.4kW 1.6kW 2.0kW OSGR (96.7mmx34.8mm) (66-82603) | TAIWAN |
| | 201-37 | | KTC |

| | | | |
|---|------------------------|--|----------------------|
|  | <p>DSA-0175</p> | <p>EMBOLO AUTOMATICO DELCO 37MT-41MT-42MT (66-1607)</p> | <p>TAIWAN</p> |
|  | <p>5-87830-504-1-D</p> | <p>EMPAQUETADURA CLOSH AUXILIAR NPR 1" DOBLE CHAPA</p> | <p>TAIWAN</p> |
|  | <p>MG-10-01030</p> | <p>ENCENDEDOR CIGARRILLOS CON LUZ AMARILLA</p> | <p>GENUINE PARTS</p> |
|  | <p>DSA-3002</p> | <p>ENCENDEDOR CIGARRILLOS CON LUZ AMARILLA</p> | <p>TAIWAN</p> |
|  | <p>TAIWAN-3005</p> | <p>ENCENDEDOR CIGARRILLOS CON LUZ TIPO HELLA LUZ VERDE</p> | <p>TAIWAN</p> |
|  | <p>TAIWAN-39</p> | <p>ESCOBILLA ALTERNADOR 12V FORD</p> | <p>TAIWAN</p> |

| | | | |
|---|------------|---|--------|
|  | RX-103F | ESCOBILLA ALTERNADOR 12V C10-C30 | TAIWAN |
|  | 211-7 | ESCOBILLAS ALTERNADOR 12V 19SI- 21SI SERIES KODIAK (5x6x22x37) (38-118) | KTC |
| | TAIWAN-117 | | TAIWAN |
|  | 211-9 | ESCOBILLAS ALTERNADOR 12V MAZDA TODOS (5.5x6.5x20x57) (38-8304) | KTC |
| | TAIWAN-119 | | TAIWAN |
|  | 211-10 | ESCOBILLA ALTERNADOR 12V TOYOTA - MITSUBISHI TODOS (5x8x18x58) (VFX55) | KTC |
| | *DSA-11 | | TAIWAN |
|  | TAIWAN-391 | ESCOBILLAS ALTERNADOR 12V NPR-NKR (5x7x21x60) (211-FIX391) | TAIWAN |
| | 211-11 | | KTC |

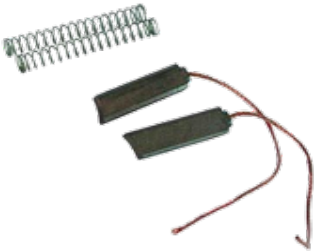
| | | | |
|---|-------------|--|--------|
| | 211-15-001 | ESCOBILLAS ALTERNADOR 12V NISSAN- CHEVROLET- GMC- MASSEY F- DEUTZ- FORD (5x7x15.5x67) (38-8102) | KTC |
| | 211-15-002 | ESCOBILLAS ALTERNADOR 12V NISSAN- CHEVROLET (38- 8103) | KTC |
| | 211-15-003 | ESCOBILLAS ALTERNADOR 12V TOYOTA M/N-HONDA- MAZDA (5x8x18.5x62) (38-8200) | KTC |
|  | 211-15-008 | ESCOBILLAS ALTERNADOR 12V TOYOTA - HYUNDAI - HONDA (5x8x23.5x69) (38-8305) | KTC |
|  | 211-17 | ESCOBILLA ALTERNADOR 24V CHEVROLET 580 (5x8x29x88) (JNS32) | KTC |
| | TAIWAN-1117 | | TAIWAN |

| | | | |
|---|-------------|---|--------|
| | 211-19 | ESCOBILLA ALTERNADOR 24V NPR - NKR (5x7x21x60) (FIX392) | KTC |
|  | 211-96 | ESCOBILLAS ALTERNADOR 12V MANDO- MITSUBISHI 5X8X18 (38-8300-VFX95) | KTC |
|  | 211-26 | ESCOBILLAS ARRANQUE 12V DE 37MT (9.5x28.5x24x33) (68-129) | KTC |
|  | TAIWAN-1129 | ESCOBILLA ARRANQUE 12V R9- VITARA BOSCH (6.5x10x16.5x30) | TAIWAN |
| | 211-29 | | KTC |
|  | 211-30- | ESCOBILLAS ARRANQUE 12V DE 10MT- SD300 SERIES CHEVROLET (6.5x19x16) (68-100) | KTC |

| | | | |
|---|-----------------|--|---------------|
|  | <p>211-31</p> | <p>ESCOBILLAS ARRANQUE 12V NISSAN SENTRA B13 B14 - CORSA DIESEL (FAX256) (4.5x14x17x32/100) (68-8128/29)</p> | <p>KTC</p> |
|  | <p>21132-DS</p> | <p>ESCOBILLA ARRANQUE 12V CORSA</p> | <p>TAIWAN</p> |
|  | <p>211-35</p> | <p>ESCOBILLAS ARRANQUE 12V FORD VAN GASOLINA BRONCO F-150- F-350-EXPLORER-FORTALEZA PMGR(4.5x16x14x35)</p> | <p>KTC</p> |
|  | <p>211-36</p> | <p>ESCOBILLAS ARRANQUE 12V FORD-DAHIATSU- NISSAN- DIESEL (8x25x20x50/40) (211-EAD)</p> | <p>KTC</p> |
|  | <p>211-37</p> | <p>ESCOBILLAS ARRANQUE 12V MAZDA MAGNETTI MARELLY (6x13x18x50/150) (211-831330)</p> | <p>KTC</p> |

| | | | |
|---|-------------|---|--------|
|  | 211-38 | ESCOBILLAS ARRANQUE 12V MAZDA MATSURI (4.5x11.8x17.5x30/113) (211-KTC8312) | KTC |
|  | 211-39 | ESCOBILLA ARRANQUE 12V MAZDA T- HYUNDAI GRACE (7x18x18.5x37) (68-8306) | KTC |
| | TAIWAN-112F | | TAIWAN |
|  | 211-41 | ESCOBILLAS ARRANQUE 12V NISSAN (VFX68) (7x12x79x45) (68-8203) | KTC |
|  | 211-43 | ESCOBILLAS ARRANQUE 12V CHEVROLET NKR 2002 (211- KTC65) (10x30x25x32) | KTC |
| | DSA-1143 | | TAIWAN |
|  | 211-44 | ESCOBILLAS ARRANQUE 12V CHEVROLET NPR- D-MAX- NISSAN (7x19x15x36) (FAX164) | KTC |
|  | DSA-RX69 | ESCOBILLAS ARRANQUE 12V 40MT DODGE P900 4 ESCOBILLAS | TAIWAN |

| | | | |
|--|------------|---|--------|
|  | 211-47 | ESCOBILLAS ARRANQUE 12V RENAULT CLIO- MEGANE- SYMBOL- R19 PARIS RHONE (9x11x18x45) | KTC |
|  | 211-49 | ESCOBILLA ARRANQUE 12V R4-6-12 FEMSA (8x17x19x30) (211-1378437) | KTC |
|  | 211-52 | ESCOBILLA ARRANQUE 12V SUPER CARRY (6.5x8x10x40) (211-KTC1032) | KTC |
| | DSA-1554F | | TAIWAN |
|  | 211-54 | ESCOBILLAS ARRANQUE 12V TOYOTA- HONDA- NISSAN- VW- CHEVROLET- YANMAR (7x11x18.5x36) (VFX54) | KTC |
| | TAIWAN-54 | | TAIWAN |
|  | TAIWAN-99F | ESCOBILLA ARRANQUE 12V TOYOTA RELACION- 22R (7x16x14x35) (68-8200-VFX99 FAX107) | TAIWAN |

| | | | |
|---|--------|--|-----|
|  | 211-56 | ESCOBILLA ARRANQUE 12V TWINGO (5x12x11.5x22) (211-BS161162) | KTC |
|  | 211-68 | ESCOBILLAS ARRANQUE 12V NIPPONDENSO TOYOTA HILUX- VIGO M/N (4.2x7.5x84x15x22) (68-8230) | KTC |
|  | 211-74 | ESCOBILLAS ARRANQUE 12V 39MT SERIES PLGR (68-152) (9.5x32x22.5x50/40) | KTC |
|  | 211-77 | ESCOBILLAS ARRANQUE 12V CHEVROLET- NISSAN- HONDA- VW- HYUNDAI- JOHN DEERE (7x11x18x46) (68-8109) | KTC |
|  | 211-78 | ESCOBILLAS ARRANQUE 12V BO HYUNDAI EXCEL- ACCENT-SUZUKI SIDECK-MITABLEROLANCER- (7x10x18x28) (68-9107) | KTC |

| | | | |
|---|-------------|---|--------|
|  | 211-79 | ESCOBILLA ARRANQUE 12V MITSUBISHI-NISSAN-TOYOTA-CHEVROLET-HYUNDAI- KIA (6.5X10X16.5X30) (68-8209) | KTC |
|  | 211-81 | ESCOBILLAS ARRANQUE 12V HYUNDAI ATOS ZAPATICO (SOLDAR) (5X10.8X12.5X25/30) | KTC |
|  | 211-82 | ESCOBILLAS ARRANQUE 12V DELCO AVEO-OPTRA-HYUNDAI- KIA | KTC |
|  | 211-86 | ESCOBILLAS ARRANQUE 12V HONDA - TOYOTA (6x13x13.5x21) (68-8220) | KTC |
|  | 211-99 | ESCOBILLAS ARRANQUE 12V DE 42MT (10.5x36.5x24.5x41) (68-112) HEAVY DUTY | KTC |
|  | TAIWAN-1042 | ESCOBILLA ARRANQUE 12V HYUNDAI ATOS | TAIWAN |

| | | | |
|---|-------------|--|--------|
|  | 212-001 | ESCOBILLAS ARRANQUE *MOTO SUZUKI GN 125 (1050) (6x10x13x22) | KTC |
|  | 212-002 | ESCOBILLAS ARRANQUE *MOTO SUZUKI GS 125 (6x9.5x10.5x32) | KTC |
|  | 211-67 | ESCOBILLA MOTOVENTILADOR GRANDE (8x8x23.5x50) | KTC |
| | TAIWAN-1167 | | TAIWAN |
|  | 211-67-001 | ESCOBILLA MOTOVENTILADOR CORTA (6.1x6.2x11.2x29) | KTC |
|  | ZKA-075-B | EXPLORADORA MAZDA BLANCA JGOx2 | TAIWAN |
|  | 2001003-B | EXPLORADORA MINI HUEVO BLANCA 9 | TAIWAN |

| | | | |
|---|----------------------|--|---------------|
|  | <p>ARTP-034-C</p> | <p>EXPLORADORA REDONDA GRANDE BLANCA</p> | <p>TAIWAN</p> |
|  | <p>FP-044-BLANCA</p> | <p>EXPLORADORA REDONDA TIPO AGRICOLA</p> | <p>TAIWAN</p> |
|  | <p>218-011</p> | <p>FIJADOR DE ROSCAS ANAEROBICO ROJO ALTA RESISTENCIA 50ML (277)</p> | <p>KTC</p> |
| | <p>218-010</p> | <p>FIJADOR DE ROSCAS ANAEROBICO ROJO ALTA RESISTENCIA 10ML (277)</p> | <p>KTC</p> |
|  | <p>DSA-27000301</p> | <p>FILTRO GASOLINA UNIVERSAL UNIVERSAL DIAMETRO 8.23MM 48X112MM *FGI-024P *G12</p> | <p>TAIWAN</p> |
|  | <p>DSA-27002601</p> | <p>FG-61 GF-61 GAS FILTER 2 HOSE + 2 CLAMP</p> | <p>TAIWAN</p> |
|  | <p>S671-12V-2P.C</p> | | <p>TAIWAN</p> |









| | | | |
|---|-------------|---|---------------|
|  | 214-011 | FLASHER DIRECCIONAL 2P 12V ELECTRÓNICO ATO 6 BOMBILLOS BAJITO | KTC |
| | 214-011-E | | GPM |
|  | MG-07-01115 | FLASHER DIRECCIONAL 2P 12V ELECTRÓNICO | GENUINE PARTS |
|  | 214-011-N | FLASHER DIRECCIONAL 2P 12V ELECTRÓNICO | KTC |
|  | 214-014-N | FLASHER DIRECCIONAL 2P 24V ELECTRÓNICO ATO 6 BOMBILLOS BAJITO | GPM |
| | DSA-14014 | | TAIWAN |
|  | 214-002-E | FLASHER DIRECCIONAL 3P 12V ELECTRÓNICO ATO 6 BOMBILLOS BAJITO | GPM |
| | 214-002 | | KTC |
| | DSA-14002 | | TAIWAN |
|  | MG-07-01116 | FLASHER DIRECCIONAL 3P 12V ELECTRÓNICO ATO 6 BOMBILLOS BAJITO | GENUINE PARTS |



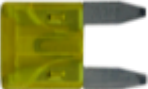

| | | | |
|--|------------------|---|---------------|
|  <p>214-015-N</p> | <p>214-015-N</p> | <p>FLASHER DIRECCIONAL 3P 24V ELECTRÓNICO ATO 6 BOMBILLOS BAJITO</p> | <p>GPM</p> |
|  <p>214-007</p> | <p>214-007</p> | <p>FLASHER DIRECCIONAL 3P 24V NPR- HINO- JAC</p> | <p>KTC</p> |
|  <p>214-005</p> | <p>214-005</p> | <p>FLASHER DIRECCIONAL 3P 12V CARROS KOREANOS - HYUNDAI-AVEO-FRONTIER-CHANA</p> | <p>KTC</p> |
|  <p>DSA-14004</p> | <p>DSA-14004</p> | <p>FLASHER DIRECCIONAL 3P 12V LUV-MAZDA</p> | <p>TAIWAN</p> |
| | <p>214-004</p> | | <p>KTC</p> |
|  <p>DSA-14999</p> | <p>DSA-14999</p> | <p>FLASHER DIRECCIONAL 8P 12V TOYOTA HILUX VIGO - 4RUNNER 04-11 (81980-0K010)</p> | <p>TAIWAN</p> |

| | | | |
|--|--------------|--|--------|
|  | 214-999 | FLASHER DIRECCIONAL 8P 12V TOYOTA HILUX VIGO - 4RUNNER 04-11 (81980-0K010) | KTC |
|  | 214-048 | FLASHER DIRECCIONAL 8P 12V TOYOTA RAV4-ECHO-COROLLA-VIOS-CAMRY-ALTIS (81980-50030) | KTC |
|  | 214-026 | FLASHER DIRECCIONAL 3P 12V VOLKSWAGEN BORA-GOLF-GOL-JETTA-POLO-SANTANA -AUDI - FOTON | KTC |
|  | 214-001 | FLASHER DIRECCIONAL 3P 12V CHEVROLET CORSA - VEHICULOS EUROPEOS DOT | KTC |
| | TAIWAN-14001 | | TAIWAN |
|  | 214-033 | FLASH 12V 8P SUZUKI SWIFT-VITARA-GRAND VITARA-VIGO-APV-XL7-ALTO-SUPER CARRY-JIMNY N/M (3861084F00-066500-5350) | TAIWAN |

| | | | |
|---|--------------|---|---------------|
|  | 214-035 | FLASHER DIRECCIONAL 3P 12V HYUNDAI CON SOPORTE (E - L - B) | KTC |
| DSA-14035 | TAIWAN | | |
|  | 214-006 | FLASHER DIRECCIONAL 3P 12V MAZDA-FORD- KIA RIO-BESTA-CERES-PRIDE-SEPHIA DOT | KTC |
| 67747 | TAIWAN | | |
|  | MG-07-01045 | FLASHER DIRECCIONAL 3P 12V HYUNDAI-KIA 12.8V (K9B066830 - DNI1127) | GENUINE PARTS |
|  | TAIWAN-14003 | FLASHER DIRECCIONAL 4P 12V RENAULT - CITROEN - PEUGEOT | TAIWAN |
| 214-003 | KTC | | |
|  | TAIWAN-14032 | FLASHER DIRECCIONAL 3P 12V E-L-B CHEVROLET-HYUNDAI-MITSUBISHI-TOYOTA-NISSAN | TAIWAN |
| 214-032 | KTC | | |

| | | | |
|---|--------------|--|--------|
|  | 214-019 | FLASHER DIRECCIONAL 4P 24V MERCEDES BENZ BUS (0335200041) | KTC |
|  | TAIWAN-14034 | FLASHER DIRECCIONAL 5P 24V CHEVROLET NQR REWARD-FRR-FTR-FSR | TAIWAN |
|  | DSA-14037 | FLASHER DIRECCIONAL 7P 12V MAZDA BT-50-MAZDA 3-MAZDA 6 05- - FORD RANGER | TAIWAN |
| | 214-037 | | KTC |
|  | 215-106-E | FUSIBLE ELECTRÓNICO ATO MICRO PATA LARGA 10AMP (ROJO) | GPM |
| | DSA-15106 | | TAIWAN |
|  | 215-109-E | FUSIBLE ELECTRÓNICO ATO MICRO PATA LARGA 15AMP (AZUL) | GPM |
| | DSA-15109 | | TAIWAN |
|  | 215-110-E | FUSIBLE ELECTRÓNICO ATO MICRO PATA LARGA 20 AMP (AMARILLO) | GPM |
| | DSA-15110 | | TAIWAN |
|  | 215-111-E | FUSIBLE ELECTRÓNICO ATO MICRO PATA LARGA 25 | GPM |

| | | | |
|---|-------------|---|--------|
|  | DSA-15111 | AMP (TRANSPARENTE) | TAIWAN |
|  | 215-107-E | FUSIBLE ELECTRÓNICO ATO MICRO PATA LARGA 30 AMP (VERDE) | GPM |
| | DSA-15107 | | TAIWAN |
| | QY-168-5A | FUSIBLE ELECTRÓNICO ATO MINI 5AMP CAJA (NARANJA) | TAIWAN |
| | 215-022 | | KTC |
|  | DSA-168-10A | FUSIBLE ELECTRONICO MINI 10AMP CX | TAIWAN |
|  | DSA-168-15A | FUSIBLE ELECTRONICO MINI 15AMP CX | TAIWAN |
|  | 215-021-E | FUSIBLE ELECTRÓNICO ATO MINI 20 AMP (AMARILLO) | |
| | 215-021 | | KTC |
| | QY-168-20A | | TAIWAN |
|  | 215-026E | FUSIBLE ELECTRÓNICO ATO MINI 25AMP (BLANCO) | GPM |
| | 215-026 | | KTC |
| | DSA-168-25A | | TAIWAN |
|  | 215-025 | FUSIBLE ELECTRÓNICO ATO MINI 30AMP (TRANSPARENTE) | KTC |
| | 215-025-E | | GPM |
| | QY-168-30 | | TAIWAN |
|  | 215-009 | FUSIBLE ELECTRÓNICO ATO 5AMP (NARANJA) | KTC |
| | DSA-169-5A | | TAIWAN |

| | | | |
|---|-----------------|---|--------|
|  | QY-169-10A | FUSIBLE ELECTRÓNICO ATO 10AMP (ROJO) | TAIWAN |
|  | QY-169-15A | FUSIBLE ELECTRÓNICO ATO 15AMP (AZUL) | TAIWAN |
|  | 215-013 | FUSIBLE ELECTRÓNICO ATO 20 AMP (AMARILLO) | KTC |
| | QY-169-20A | | TAIWAN |
|  | 215-014 | FUSIBLE ELECTRÓNICO ATO 25 AMP (TRANSPARENTE) | KTC |
| | QY-169-25A | | TAIWAN |
|  | 215-010 | FUSIBLE ELECTRÓNICO ATO 30AMP (VERDE) | KTC |
| | QY-169-30A | | TAIWAN |
|  | 215-015 | FUSIBLE ELECTRÓNICO ATO 40AMP (NARANJA) | KTC |
|  | DSA-S1036-3-20A | FUSIBLE ELECTRONICO MAXI 20AMP (AMARILLO) | TAIWAN |
| | 215-028-E | | GPM |

| | | | |
|---|------------------------|---|---------------|
|  | <p>DSA-S1036-3-30A</p> | <p>FUSIBLE ELECTRONICO MAXI 30AMP (VERDE)</p> | <p>TAIWAN</p> |
|  | <p>215-029-E</p> | | <p>GPM</p> |
|  | <p>DSA-S1036-3-40A</p> | <p>FUSIBLE ELECTRONICO MAXI 40 AMP (ANARANJADO)</p> | <p>TAIWAN</p> |
|  | <p>215-030-E</p> | | <p>GPM</p> |
|  | <p>DSA-S1036-3-50A</p> | <p>FUSIBLE ELECTRONICO MAXI 50 AMP (ROJO)</p> | <p>TAIWAN</p> |





| | | | |
|---|------------------------|--|---------------|
|  | <p>DSA-S1036-3-60A</p> | <p>FUSIBLE ELECTRONICO MAXI 60 AMP (AZUL)</p> | <p>TAIWAN</p> |
|  | <p>DSA-S1036-3-80A</p> | <p>FUSIBLE ELECTRONICO MAXI 80 AMP (TRANSPARENTE)</p> | <p>TAIWAN</p> |
|  | <p>215-097-E</p> | <p>FUSIBLE PRINCIPAL MINI MINI HEMBRA 20AMP (AZUL)</p> | <p>GPM</p> |
|  | <p>215-098-E</p> | <p>FUSIBLE PRINCIPAL MINI MINI HEMBRA 25AMP (BLANCO)</p> | <p>GPM</p> |
|  | <p>DSA-S1041-13-30</p> | <p>FUSIBLE PRINCIPAL MINI MINI HEMBRA 30AMP (ROSADO)</p> | <p>TAIWAN</p> |
| | <p>215-099-E</p> | | <p>GPM</p> |
|  | <p>DSA-S1041-13-40</p> | <p>FUSIBLE PRINCIPAL MINI MINI HEMBRA 40AMP (VERDE)</p> | <p>TAIWAN</p> |

| | | | |
|---|-----------------|--|--------|
|  | 215-101-E | FUSIBLE PRINCIPAL MINI MINI HEMBRA HEMBRA 50AMP (ROJO) | GPM |
|  | DSA-S1041-13-50 | | TAIWAN |
|  | 215-102-E | FUSIBLE PRINCIPAL MINI MINI HEMBRAHEMBRA 60AMP (AMARILLO) | GPM |
|  | DSA-S1041-13-60 | | TAIWAN |
|  | 215-113-E | FUSIBLE PRINCIPAL MINI HEMBRA 20AMP (BLANCO) | GPM |
|  | DSA-S1041-5-20A | FUSIBLE PRINCIPAL MINI HEMBRA 20AMP (AZUL) | TAIWAN |

| | | | |
|---|------------------------|---|---------------|
|  | <p>DSA-S1041-5-40A</p> | <p>FUSIBLE PRINCIPAL MINI HEMBRA 40AMP (VERDE)</p> | <p>TAIWAN</p> |
|  | <p>DSA-S1041-5-50A</p> | <p>FUSIBLE PRINCIPAL MINI HEMBRA 50AMP (ROJO)</p> | <p>TAIWAN</p> |
|  | <p>215-115-E</p> | | <p>GPM</p> |
|  | <p>DSA-S1041-5-60A</p> | <p>FUSIBLE PRINCIPAL MINI HEMBRA 60AMP (AMARILLO)</p> | <p>TAIWAN</p> |
|  | <p>215-038-E</p> | <p>FUSIBLE PRINCIPAL HEMBRA 30AMP (ROSADO)</p> | <p>GPM</p> |
|  | <p>DSA-S1041-4-30A</p> | | <p>TAIWAN</p> |

| | | | |
|---|------------------------|---|---------------|
|  | <p>DSA-S1041-4-40A</p> | <p>FUSIBLE PRINCIPAL HEMBRA 40AMP (NEGRO)</p> | <p>TAIWAN</p> |
|  | <p>DSA-S1041-4-50A</p> | <p>FUSIBLE PRINCIPAL HEMBRA 50AMP (NEGRO)</p> | <p>TAIWAN</p> |
|  | <p>DSA-S1041-4-60A</p> | <p>FUSIBLE PRINCIPAL HEMBRA 60AMP (NEGRO)</p> | <p>TAIWAN</p> |
|  | <p>215-042-E</p> | <p>FUSIBLE PRINCIPAL HEMBRA 80AMP (NEGRO)</p> | <p>GPM</p> |
|  | <p>DSA-S1041-4-80A</p> | | <p>TAIWAN</p> |

| | | | |
|---|-----------------|--|--------|
|  | DSA-S1041-4-100 | FUSIBLE PRINCIPAL HEMBRA 100AMP (AZUL) | TAIWAN |
|  | DSA-S1041-1-40A | FUSIBLE PRINCIPAL MACHO 40AMP (VERDE) | TAIWAN |
|  | DSA-S1041-1-50A | FUSIBLE PRINCIPAL MACHO 50AMP (ROJO) | TAIWAN |
|  | DSA-S1041-1-60A | FUSIBLE PRINCIPAL MACHO 60AMP (AMARILLO) | TAIWAN |
|  | DSA-S1041-1-80A | FUSIBLE PRINCIPAL MACHO 80AMP (NEGRO) | TAIWAN |

| | | | |
|---|------------------|--|--------|
|  | 215-056-E | FUSIBLE PRINCIPAL MACHO 80AMP (NEGRO) | GPM |
|  | DSA-S1041-1-100 | FUSIBLE PAL MACHO 100AMP (AZUL) | TAIWAN |
|  | TAIWAN-S1033-10A | FUSIBLE.VIDRIO 10AMP CX100 | TAIWAN |
| | TAIWAN-S1033-20A | FUSIBLE.VIDRIO 20AMP CX100 | TAIWAN |
| | 215-005-E | | GPM |
| | TAIWAN-S1033-25A | FUSIBLE.VIDRIO 25AMP CX100 | TAIWAN |
| | 215-006-E | | GPM |
| | TAIWAN-S1033-30A | FUSIBLE.VIDRIO 30AMP CX100 | TAIWAN |
| 215-002-E | GPM | | |
|  | YX02001-DS | GATO HIDRAULICO BOTELLA 2 TONELADAS CAJA CARTÓN | TAIWAN |
| | YX02002-DS | GATO HIDRÁULICO BOTELLA 3 TONELADAS CAJA CARTÓN | TAIWAN |
| | YX02005-DS | GATO HIDRÁULICO BOTELLA 6 TONELADAS CAJA CARTÓN | TAIWAN |
| | YX02007-DS | GATO HIDRÁULICO BOTELLA 10 TONELADAS CAJA CARTÓN | TAIWAN |
| | YX02008-DS | GATO HIDRÁULICO BOTELLA 12 TONELADAS CAJA CARTÓN | TAIWAN |
| | YX02009-DS | GATO HIDRÁULICO BOTELLA 16 TONELADAS CAJA CARTÓN | TAIWAN |
| | YX2010-DS | GATO HIDRÁULICO BOTELLA 20 TONELADAS CAJA CARTÓN | TAIWAN |

| | | | |
|---|--------------|---|--------|
|  | YX2011A-DS | GATO HIDRÁULICO BOTELLA 30 TONELADAS CAJA CARTÓN | TAIWAN |
| | YX2011B-DS | GATO HIDRÁULICO BOTELLA 32 TONELADAS CAJA CARTÓN | TAIWAN |
| | YX02012-DS | GATO HIDRÁULICO BOTELLA 50 TONELADAS CAJA CARTÓN | TAIWAN |
|  | ES-8 | MAGNETO DISTRIBUCION DODGE ELE | TAIWAN |
|  | DSA-52006101 | MIONA CON LUZ UNIVERSAL NEGRA | TAIWAN |
|  | TAIWAN-290-A | GRIFO CON LUZ UNIVERSAL BLANCO JUEGO X 2 | TAIWAN |
|  | 216-018 | HORÓMETRO REDONDO 12-24V TABLERO NEGRO-ARO CROMADO | GPM |
|  | 216-047 | HORÓMETRO REDONDO DIGITAL 9-32V TABLERO NEGRO-ARO NEGRO | KTC |

| | | | |
|---|--------------|---|--------|
|  | 216-026 | TACÓMETRO DIESEL ELÉCTRICO 0-4000RPM 3 3/4 12-24V TABLERO NEGRO-ARO NEGRO | KTC |
|  | 216-027- | TACÓMETRO DIESEL ELÉCTRICO 0-4000RPM 3 3/4 12-24V TABLEROBLANCO-ARO NEGRO KTC | KTC |
|  | 216-028 | TACÓMETRO DIESEL ELÉCTRICO 0-6000RPM 2" (NPR- NKR-MAZDA T-DAIHATSU) TABLERONEGRO-ARO NEGRO | KTC |
|  | 216-036 | TACÓMETRO-HORÓMETRO DIESEL ELECTRÓNICO 3000RPM 12-24V 3 3/8" TABLERONEGRO-ARO CROMADO GPM | GPM |
|  | TAIWAN-16006 | MEDIDOR ACEITE MECÁNICO 150L TABLERO NEGRO- ARO CROMADO | TAIWAN |



| | | | |
|--|-------------|---|--------|
|  | 216-068 | MEDIDOR ACEITE MECÁNICO 80L TABLERO BLANCO-ARO CROMADO | KTC |
|  | 216-034 | MEDIDOR ACEITE MECÁNICO 80L TABLERO NEGRO-ARO CROMADO | KTC |
|  | S-1003-A016 | MEDIDOR ACEITE MECÁNICO 80L TABLERO NEGRO-ARO CROMADO | TAIWAN |
|  | DSA-16021 | MEDIDOR AIRE AGUJA SENCILLA MECÁNICO 150PSI T.NEGRO-ARO CROMADO KTC | TAIWAN |

| | | | |
|---|--------------|---|--------|
|  | 216-022 | MEDIDOR AIRE AGUJA DOBLE MECANICO T.NEGRO-ARO NEGRO | KTC |
|  | 216025-DS | MEDIDOR COMBUSTIBLE (GASOLINA) UNIVERSAL TABLERO NEGRO-ARO NEGRO | TAIWAN |
| | 216-025 | | KTC |
|  | TAIWAN-16029 | MEDIDOR COMBUSTIBLE (GASOLINA-DIESEL) 12V CON FLOTADOR | TAIWAN |
|  | 216-077 | MEDIDOR <u>TEMPERATURA DEL ACEITE</u> ELÉCTRICO 12V CON SENSOR TABLERO NEGRO - ARO CROMADO | GPM |

| | | | |
|---|---------------|---|--------|
|  | 216-012 | MEDIDOR TEMPERATURA ELÉCTRICO 12V CON PERA TABLERO NEGRO - ARO CROMADO | GPM |
|  | 216-040 | MEDIDOR TEMPERATURA MECÁNICO GUAYA 144" TABLERO NEGRO - ARO NEGRO | GPM |
| | TAIWAN-0837 | MEDIDOR TEMPERATURA MECÁNICO GUAYA 144" TABLERO NEGRO - ARO NEGRO | TAIWAN |
|  | 216-004 | MEDIDOR TEMPERATURA MECÁNICO GUAYA PLÁSTICA 144" TABLERO NEGRO - ARO CROMADO | GPM |
| | TAIWAN-216004 | | TAIWAN |
|  | TAIWAN-5511-S | MEDIDOR TEMPERATURA MECÁNICO GUAYA METÁLICA 72" TABLERO NEGRO - ARO CROMADO | TAIWAN |
| | 216-079 | | GPM |
|  | 5510S-90W | MEDIDOR TEMPERATURA MECÁNICO GUAYA PLÁSTICA 72" TABLERO BLANCO - ARO CROMADO | TAIWAN |
| | 5510S-90MT-BL | MEDIDOR TEMPERATURA MECÁNICO GUAYA METÁLICA 72" TABLERO BLANCO - ARO CROMADO | TAIWAN |
| | 216-069 | | KTC |

| | | | |
|---|---------------|--|--------|
|  | 216-039 | MEDIDOR TEMPERATURA MECÁNICO GUAYA 72" TABLERO NEGRO - ARO NEGRO | GPM |
|  | 216-003 | MEDIDOR TEMPERATURA MECÁNICO GUAYA 72" TABLERO NEGRO - ARO CROMADO | GPM |
|  | 216-035 | MEDIDOR TEMPERATURA MECÁNICO GUAYA 72" TABLERO NEGRO - ARO CROMADO | KTC |
| | TAIWAN-40566 | | TAIWAN |
|  | 5590-WH | MEDIDOR TRIPLE (AMPERIMETRO 60-60-ACEITE 0-80PSI- TEMPERATURA 60°-120°) TABLERO BLANCO - ARO CROMADO - SOPORTE CROMADO | TAIWAN |
|  | TAIWAN-5512-S | MEDIDOR TRIPLE (VOLTÍMETRO 8-16V - TEMPERATURA 40°-120° - ACEITE 0-7KG) TABLERO BLANCO - ARO NEGRO - SOPORTE NEGRO | TAIWAN |
|  | 5590-BK | MEDIDOR TRIPLE (AMPERIMETRO 60-60 - ACEITE 0-80PSI- TEMPERATURA 100°-220°) TABLERO NEGRO - ARO CROMADO - SOPORTE NEGRO | TAIWAN |

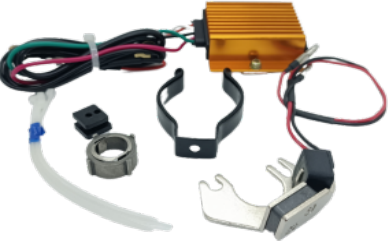
| | | | |
|---|----------------|---|--------|
|  | 216-024 | MEDIDOR TRIPLE (AMPERIMETRO 50-50 - ACEITE 0-80PSI-TEMPERATURA 100°-220°) TABLERO NEGRO - ARO CROMADO - SOPORTE CROMADO | KTC |
|  | TAIWAN-5001201 | MODULO IGNICIÓN ELECTRÓNICO B60-C70 | TAIWAN |
|  | DSA-350 | MODULO TIPO PORTER DAHIATF20 - SUZUKI | TAIWAN |
|  | MIB-352 | MODULO TIPO PORTER SUPER CARRY - SUZUKI | TAIWAN |
|  | TAIWAN-353 | MODULO TIPO PORTER TOYOTA 6C. SISTEMA PLATINOS | TAIWAN |

| | | | |
|---|----------------|--|---------------|
|  | <p>MIB-354</p> | <p>MODULO TIPO PORTER RENAULT 4-6-12 SISTEMA PLATINOS</p> | <p>TAIWAN</p> |
|  | <p>DSA-355</p> | <p>MODULO TIPO PORTER MAZDA B2.000 - MONTERO</p> | <p>TAIWAN</p> |
|  | <p>DSA-356</p> | <p>MODULO TIPO PORTER PANELA UNIVERSAL *SIRVE PARA TODOS LOS MODULOS TIPO PROTER</p> | <p>TAIWAN</p> |
|  | <p>DSA-357</p> | <p>MODULO TIPO PORTER NISSAN 6 CILINDROS</p> | <p>TAIWAN</p> |





| | | | |
|--|--------------------|--|----------------------|
|  | <p>MIB-358</p> | <p>MODULO TIPO PORTER NISSAN 4 CILINDROS</p> | <p>TAIWAN</p> |
|  | <p>MG-10-01309</p> | <p>MOTOR BLOQUEO CENTRAL DE BAÚL 2P (7700435694, 8200102583, 7700427088, 8200060917, 7701473742, N0501380)</p> | <p>GENUINE PARTS</p> |
|  | <p>HS-201-A</p> | <p>MOTOR TANQUE LIMPIABRISAS TOYOTA 12V</p> | <p>TAIWAN</p> |
|  | <p>HS-206-B</p> | <p>MOTOR TANQUE LIMPIABRISAS CHEVROLET ATOS - SPARK 12V</p> | <p>TAIWAN</p> |
|  | <p>HS-260-B</p> | <p>MOTOR TANQUE LIMPIABRISAS RENAULT CLIO - KANGOO 12V</p> | <p>TAIWAN</p> |





| | | | |
|--|--------------|--|--------|
| | HS-350-A | MOTOR TANQUE LIMPIABRISAS MAZDA 12V | TAIWAN |
|  | HS-209-A | MOTOR TANQUE LIMPIABRISAS UNIVERSAL 12V | TAIWAN |
|  | TAIWAN-31229 | MOTOR MOTOVENTILADOR 12V SWIFT 1.0-1.3 | TAIWAN |
|  | 217-001 | MOTOR MOTOVENTILADOR 12V NISSAN TSURU (21487-58Y00) | KTC |
|  | 217-002 | MOTOR MOTOVENTILADOR 12V HYUNDAI ATOS-SANTRO HATCHBACK (25386-02000) | KTC |



| | | | |
|---|---------|--|--------|
|  | 217-007 | MOTOR MOTOVENTILADOR 12V RENAULT LOGAN-SANDERO (6001550769)) (213-124) | KTC |
|  | RX-045 | MOTOR MOTOVENTILADOR MAZDA 323-686-ASAHI-MILENIO-MATSURI (F201-15-150) | TAIWAN |
| | 217-010 | | KTC |
|  | 217-008 | MOTOR MOTOVENTILADOR 12V CHEVROLET SPARK 7:24 (93741007) | KTC |
|  | 217-011 | MOTOR MOTOVENTILADOR 12V TOYOTA YARIS 07-12-VIOS (213-125) (1636328160) TORNILLO CENTRAL CON DOS MEDIAS LUNAS Y TUERCA ROSCABLE MOTOVENTILADOR | KTC |

| | | | |
|---|----------------|---|------------|
|  | <p>217-013</p> | <p>MOTOR MOTOVENTILADOR 12V TOYOTA COROLLA 1.8 09-14 (16363-22120)</p> | <p>KTC</p> |
|  | <p>213-100</p> | <p>MOTOVENTILADOR 12V CHEVROLET CORSA-CHEVY-VECTRA-ASTRA (0130303244)</p> | <p>KTC</p> |
|  | <p>213-103</p> | <p>MOTOVENTILADOR 12V HYUNDAI I10 M/N (25380-0X550)</p> | <p>KTC</p> |
|  | <p>213-104</p> | <p>MOTOVENTILADOR 12V HYUNDAI ACCENT 00-05-VERNA (25380-25000)</p> | <p>KTC</p> |

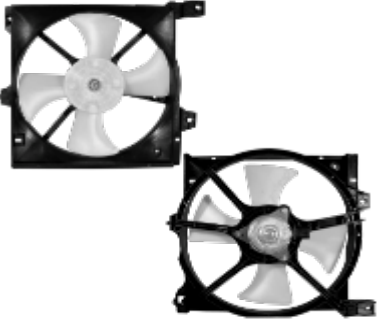
| | | | |
|---|----------------|---|------------|
|  | <p>213-108</p> | <p>MOTOVENTILADOR 12V KIA CERATO- FORTE-FORTE KOUNP (25380-1M050)</p> | <p>KTC</p> |
|  | <p>213-109</p> | <p>MOTOVENTILADOR 12V RENAULT CLIO-KANGOO-MEGANE-SYMBOL-CITIUS-N.PLATINA LOGAN (7701070217)</p> | <p>KTC</p> |
|  | <p>213-110</p> | <p>MOTOVENTILADOR 12V RENAULT LOGAN-SANDERO M/N (8200779073)</p> | <p>KTC</p> |
|  | <p>213-111</p> | <p>MOTOVENTILADOR 12V CHEVROLET AVEO 1.6 05-08 A/A - DAEWOO KALOS (96536666)</p> | <p>KTC</p> |

| | | | |
|---|----------------|---|------------|
|  | <p>213-114</p> | <p>MOTOVENTILADOR 12V CHEVROLET SAIL (9023973)</p> | <p>KTC</p> |
|  | <p>213-116</p> | <p>MOTOVENTILADOR 12V RENAULT TWINGO (7701206548)</p> | <p>KTC</p> |
|  | <p>213-120</p> | <p>MOTOVENTILADOR 12V MAZDA ALLEGRO 95-09 A/A</p> | <p>KTC</p> |
|  | <p>213-123</p> | <p>MOTOVENTILADOR 12V FORD FIESTA-MAZDA 2 (ZJ3615025)</p> | <p>KTC</p> |

| | | | |
|--|---------|---|-----|
|  | 213-124 | MOTOVENTILADOR 12V RENAULT LOGAN 04-12- SANDERO 08-13-CLIO-SYMBOL (6001550769) | KTC |
|  | 213-125 | MOTOVENTILADOR 12V TOYOTA YARIS 07-12-VIOS (16711- 0M060) | KTC |
|  | 213-127 | MOTOVENTILADOR 12V NISSAN SENTRA-TSURU III 00/ (21487-75Y00) | KTC |
|  | 213-129 | MOTOVENTILADOR 12V HYUNDAI GRAND I10 (25380- B4000) | KTC |

| | | | |
|---|--|--|--------|
|  | 213-130 | MOTOVENTILADOR 12V HYUNDAI ACCENT I25- I30-KIA K2-RIO 11-05 (25380-1R050) | KTC |
|  | 213-136 | MOTOVENTILADOR 12V CHEVROLET SPARK GT (95978940) | KTC |
|  | TAIWAN-33825 | MOTOVENTILADOR UNIVERSAL 7" 12V GIRO DERECHO - VENTILACION HACIA AFUERA 80 WATTS | TAIWAN |
| | 213-009 | MOTOVENTILADOR UNIVERSAL 9" 12V GIRO DERECHO - VENTILACION HACIA AFUERA 80 WATTS | KTC |
| | TAIWAN-11030 | MOTOVENTILADOR UNIVERSAL 10" 12V GIRO DERECHO - VENTILACION HACIA AFUERA 80 WATTS | TAIWAN |
| | 213-001 | | KTC |
| | TAIWAN-31219 | MOTOVENTILADOR UNIVERSAL 12" 12V GIRO DERECHO - VENTILACION HACIA AFUERA 100 WATTS | TAIWAN |
| | 213-002 | | KTC |
| | TAIWAN-17159 | MOTOVENTILADOR UNIVERSAL 14" 12V GIRO DERECHO - VENTILACION HACIA AFUERA 100 WATTS | TAIWAN |
| | 213-003 | | KTC |
| | TAIWAN-38443 | MOTOVENTILADOR UNIVERSAL 10" 24V GIRO DERECHO - VENTILACION HACIA AFUERA 80 WATTS | TAIWAN |
| | 213-005 | MOTOVENTILADOR UNIVERSAL 12" 24V GIRO DERECHO - VENTILACION HACIA AFUERA 80 WATTS | KTC |
| TAIWAN-38444 | TAIWAN | | |
| 213-006 | MOTOVENTILADOR UNIVERSAL 14" 24V GIRO DERECHO - VENTILACION HACIA AFUERA 100 WATTS | KTC | |







| | | | |
|---|--------------------|---|---------------|
|  | <p>DSA-26807</p> | <p>LICUADORA MONTACARGA LUZ ALTO PODER DE PREVENCIÓN(120*100 mm) 30 LED AMBAR 1 FUN CON KIT DE LENTE BLANCO CABLES 110V</p> | <p>TAIWAN</p> |
| <p>326-807-KW</p> | <p>KTC</p> | | |
|  | <p>326-809-KW</p> | <p>LICUADORA ALTO PODER DE PREVEN 40 LED 5730SMD AMBAR Y LENTE CRISTAL 2 FUNC/S C/ENCENDEDOR IMAN TORN/O</p> | <p>KTC</p> |
|  | <p>321-02-6052</p> | <p>ÓPTICA RECTANGULAR GRANDE P43 8"X6" CON PILOTO REFLECTOR DE METAL</p> | <p>KTC</p> |
|  | <p>321-01-4652</p> | <p>ÓPTICA RECTANGULAR PEQUEÑA P43 6"X4" SIN PILOTO REFLECTOR DE METAL</p> | <p>KTC</p> |
| | <p>321-02-4652</p> | <p>ÓPTICA RECTANGULAR PEQUEÑA P43 6"X4" CON PILOTO REFLECTOR DE METAL</p> | <p>KTC</p> |
|  | <p>321-01-6014</p> | <p>ÓPTICA REDONDA GRANDE P43 7" SIN PILOTO REFLECTOR DE METAL</p> | <p>KTC</p> |
| | <p>321-02-6014</p> | <p>ÓPTICA REDONDA GRANDE P43 7" CON PILOTO REFLECTOR DE METAL</p> | <p>KTC</p> |
|  | <p>321-02-4000</p> | <p>ÓPTICA REDONDA PEQUEÑA P43 5 3/4" CON PILOTO REFLECTOR DE METAL</p> | <p>KTC</p> |

| | | | |
|--|----------------|---|---------------|
|  | <p>DSA-32P</p> | <p>PACHAS 2 VÍAS MACHO CON CABLE Y TERMINALES ENCHUFE(T094 - 6.3MM) + PIN CARRO</p> | <p>TAIWAN</p> |
|  | <p>DSA-33P</p> | <p>PACHAS 3 VÍAS MACHO CON CABLE Y TERMINALES ENCHUFE(T094 - 6.3MM) + PIN CARRO</p> | <p>TAIWAN</p> |
|  | <p>DSA-34P</p> | <p>PACHAS 4 VÍAS MACHO CON CABLE Y TERMINALES ENCHUFE(T094 - 6.3MM) + PIN CARRO</p> | <p>TAIWAN</p> |
|  | <p>DSA-36P</p> | <p>PACHAS 6 VÍAS MACHO CON CABLE Y TERMINALES ENCHUFE(T094 - 6.3MM) + PIN CARRO</p> | <p>TAIWAN</p> |
|  | <p>DSA-38P</p> | <p>PACHAS 8 VÍAS MACHO CON CABLE Y TERMINALES ENCHUFE(T094 - 6.3MM) + PIN CARRO</p> | <p>TAIWAN</p> |

| | | | |
|---|--------------|---|--------|
|  | 016015902-DS | PACHAS 2 VÍAS HEMBRA Y MACHO SIN CABLE CON TERMINALES ENCHUFE(T094) + PIN CARRO | TAIWAN |
|  | 016015903-DS | PACHAS 3 VÍAS HEMBRA Y MACHO SIN CABLE CON TERMINALES ENCHUFE(T094) + PIN CARRO | TAIWAN |
|  | 016015904-DS | PACHAS 4 VÍAS HEMBRA Y MACHO SIN CABLE CON TERMINALES ENCHUFE(T094) + PIN CARRO | TAIWAN |
|  | 016015905-DS | PACHAS 6 VÍAS HEMBRA Y MACHO SIN CABLE CON TERMINALES ENCHUFE(T094) + PIN CARRO | TAIWAN |
|  | DSA-82P | PACHAS 2 VÍAS MACHO CON CABLE Y TERMINALES PARLANTE(2.8MM) + PIN MOTO | TAIWAN |

| | | | |
|---|---------------------|--|---------------|
|  | <p>DSA-83P</p> | <p>PACHAS 3 VÍAS MACHO CON CABLE Y TERMINALES PARLANTE(2.8MM) + PIN MOTO</p> | <p>TAIWAN</p> |
|  | <p>DSA-84P</p> | <p>PACHAS 4 VÍAS MACHO CON CABLE Y TERMINALES PARLANTE(2.8MM) + PIN MOTO</p> | <p>TAIWAN</p> |
|  | <p>DSA-86P</p> | <p>PACHAS 6 VÍAS MACHO CON CABLE Y TERMINALES PARLANTE(2.8MM) + PIN MOTO</p> | <p>TAIWAN</p> |
|  | <p>DSA-89P</p> | <p>PACHAS 8 VÍAS MACHO CON CABLE Y TERMINALES PARLANTE(2.8MM) + PIN MOTO</p> | <p>TAIWAN</p> |
|  | <p>013002902-DS</p> | <p>PACHAS 3 VÍAS HEMBRA Y MACHO SIN CABLE CON TERMINALES PARLANTE + PIN MOTO</p> | <p>TAIWAN</p> |

| | | | |
|---|--------------|---|--------|
|  | 013002903-DS | PACHAS 4 VÍAS HEMBRA Y MACHO SIN CABLE CON TERMINALES PARLANTE + PIN MOTO | TAIWAN |
|  | 01300904-DS | PACHAS 6 VÍAS HEMBRA Y MACHO SIN CABLE CON TERMINALES PARLANTE + PIN MOTO | TAIWAN |
|  | 013002905-DS | PACHAS 2 VÍAS HEMBRA Y MACHO SIN CABLE CON TERMINALES PARLANTE + PIN MOTO | TAIWAN |
|  | DSA-990 | PACHAS 4 VÍAS HEMBRA Y MACHO SIN CABLE NEGRO | TAIWAN |
|  | TAIWAN-19072 | PERA ACEITE 1P AVEO-SAIL-OPTRA 1.8-CRUZE 09-- CAPTIVA 06--LANOS 98-02 | TAIWAN |
| | 219-072 | | KTC |

| | | | |
|---|--------------|---|--------|
|  | 219-001 | PERA ACEITE 1P DAHIATSU DELTA 14B-HILUX-COROLLA 93-14-CAMRY 92-14-4RUNNER 92-14-YARIS 07-14-RAV4 96-14- | KTC |
|  | 219-002 | PERA ACEITE 1P HYUNDAI-MAZDA-NISSAN-SPRINT-SWIFT-VITARA 99-02-GRAND V.99-02 | KTC |
| | TAIWAN-67180 | | TAIWAN |
|  | DSA-19096 | PERA ACEITE 1P CHEVROLET NKR-NPR-NQR-DMAX-FSR-FTR-FVR | TAIWAN |
| | 219-096 | | KTC |
|  | TAIWAN-19003 | PERA ACEITE 1P LUV1600-2300-NKR-NPR-MAZDA T-TROOPER | TAIWAN |
| | 219-003 | | KTC |
|  | 219-123 | PERA ACEITE 1P NISSAN TIIDA-PATHFINDER-SENTRA-VERSA-MURANO-ALTIMA-INFINITI 2010- | KTC |
|  | 219-005 | PERA ACEITE 1P NISSAN SENTRA-ALTIMA-D21-FRONTIER-MAXIMA-PATHFINDER-PRIMERA-PULSAR | KTC |
|  | 219-083 | PERA ACEITE 1P HYUNDAI ACCENT -H100-ATOS-GETZ-TOYOTA CAMRY-HILUX-LAND CRUISER-COROLLA | KTC |

| | | | |
|---|--------------|--|---------------|
|  | TAIWAN-19985 | PERA ACEITE 1P RENAULT LOGAN-SANDERO-CLIO-MEGANE II | TAIWAN |
| 219-985 | KTC | | |
|  | TAIWAN-19607 | PERA ACEITE CHEVROLET CORSA-AVEO-OPTRA 1.8 | TAIWAN |
|  | 219-008 | PERA FRENO 2P CHEVROLET CORSA (TODOS) - CHEVY - MONZA | KTC |
|  | DSA-19009 | PERA FRENO 2P DAIHATSU F20-FEROZA-ROCKY-SPORTACK | TAIWAN |
| 219-009 | KTC | | |
|  | 219-010 | PERA FRENO 2P HYUNDAI ACCENT 00--ATOS PRIME 04--GETZ-H100-SANTAFE 01-03-KIA PICANTO-CARENS-PRIDE-SPORTAGE- | KTC |
| TAIWAN-19010 | TAIWAN | | |
|  | 219-011 | PERA FRENO 2P HYUNDAI ACCENT 00-ELANTRA 1.6-1.8 91--EXCEL 89/-PONY 85/-PRECIS 1.5 89/-SONATA-STELL | KTC |
|  | MG-04-01356 | PERA FRENO 2P HYUNDAI HYUNDAI SANTA FE- ELANTRA - TUCSON (938101C100 - 9381022100) | GENUINE PARTS |

| | | | |
|---|---------------|---|---------------|
|  | DSA-19013 | PERA FRENO 2P CHEVROLET LUV 2.3-TROOPER-WFR-RODEO-PATHFINDER | TAIWAN |
| | 219-013 | | KTC |
|  | TAIWAN-67170 | PERA FRENO 2P MAZDA 323-626-PROTEGE-MX3-MX6-T45-B1.6-B2.0-CARRY-SWIFT | TAIWAN |
|  | 219-018 | PERA FRENO 2P CHEVROLET NPR-NQR- AMIGO 89-94-98-00-IMPULSE 90-92-RODEO 91-03 | KTC |
| | 67171 | | TAIWAN |
| | 31693 | | TAIWAN |
|  | 219-019 | PERA FRENO 2P RENAULT 4-6-12-PEUGEOT 104-204-205 72-94-304-305 69-88 - 504 68-84-505 79-81 | KTC |
|  | MG-04-01721 | PERA FRENO 4P RENAULT LOGAN 2015 -SANDERO -DUSTER | GENUINE PARTS |
|  | 219-982-E | PERA FRENO 4P RENAULT DUSTER-LOGAN-LOGAN 2-SANDERO 2-CLIO III-MODUS-WIND (253206170R) | KTC |
|  | TAIWAN-19MS43 | PERA FRENO 2P MS43 CHRYSLER 68-83- FORD TRUCK 68-80-IHC 73-83-AMC 80-83 (12612191362835 1362959 14074323 1632865) | TAIWAN |
| | 219-021 | | KTC |
| | MG-04-01245 | | GENUINE PARTS |

| | | | |
|---|--------------|---|---------------|
|  | 219-090 | PERA FRENO AHOGO 2P NKR-NPR | KTC |
| | TAIWAN-19090 | | TAIWAN |
|  | 111-13250E | PERA FRENO DE AIRE (LUCES) 1 POLO - 2 TERMINALES SE ACTIVA A 3 PSI. | GPM |
| | TAIWAN-19607 | | TAIWAN |
|  | MG-04-01651 | PERA FRENO DAEWOO RACER - CIELO - SPARK 724 - MATIZ (90196375 - 94580647 - 96567247) | GENUINE PARTS |
|  | 219-106 | PERA FRENO 2P NISSAN FRONTIER 05-14-PATHFINDER 06-14-MARCH 05-14-TIIDA 07-14-X-TRAIL 07-14-KOLEOS | KTC |
|  | 219-124 | PERA FRENO 2P HYUNDAI H1-STAREX-ELANTRA-I10-I20-I30-IX35-SANTAFE -TUCSON-KIA CARNIVAL-PICANTO-CERATO | KTC |
|  | 219-131-E | PERA FRENO 2C CHEVROLET D-MAX 2.4-2.5-3.5 (2 TERMINALES) | GPM |
| | 219-140-E | PERA FRENO 4P MAZDA 2 2011-2014/MAZDA 3 2004-2020/MAZDA 5 2006-2015/MAZDA 6 2014-2020/MAZDA CX-3 2016-2020/MAZDA CX-30 2020/MAZDA CX-5 2013-2020/MAZDA CX-9 2016-2020/MAZDA MX-5 MIATA 2009-2020/SCION IA 2016/TOYOTA YARIS 2019-2020/TOYOTA YARIS IA 2017-2018 (84340WB002 BN7N66490 BN7N66490A) | GPM |
| | MG-04-02260 | | GENUINE PARTS |

| | | | |
|---|----------------|--|---------------|
|  | 219-986 | PERA FRENO 4P HYUNDAI I10 - I30-IX25- IX35- TUCSON-KIA PICANTO-SOUL (938133S800) | KTC |
|  | TAIWAN-19992 | PERA FRENO 4P RENAULT LOGAN-SANDERO-CLIO-TWINGO-LAGUNA (8200276361) | TAIWAN |
| | MG-04-01391 | | GENUINE PARTS |
|  | MG-04-01299 | PERA FRENO 4P MITSUBISHI-NISSAN-RENAULT CLIO-ESPACE-KANGOO-MASTER-LAGUNA-TRAFIC II-TWINGO (25320-00QAA 4415882 4404452 93852863 414988 7700414988 MR977584 09112452) | GENUINE PARTS |
|  | 219-994 | PERA FRENO 2P RENAULT LOGAN 04-12-SANDERO 08-13-TWINGO M/N-CLIO-SYMBOL-MEGAN | GPM |
| | TAIWAN-19994 | | TAIWAN |
|  | MG-04-01222 | PERA FRENO 2P RENAULT LOGAN 04-12-SANDERO 08-13-TWINGO M/N-CLIO-SYMBOL-MEGAN (9160984 2532000QAB 4414063 4500684 7700414986) | GENUINE PARTS |
|  | MG-04-01414 | PERA FRENO 2P RENAULT LOGAN (8200209496) | GENUINE PARTS |
|  | 219-996 | PERA FRENO 4P CHEVROLET D-MAX- TOYOTA VIGO-HILUX-PRADO 03-14-YARIS 09-12-4RUNNER 10-12 | KTC |
|  | TAIWAN-1950132 | PERA FRENO 2P NISSAN PATROL UNIVERSAL | TAIWAN |

| | | | |
|---|--------------|--|--------|
|  | 219-987 | PERA FRENO 4P CHEVROLET SAIL- AVEO- OPTRA - MATIZ - SPARK | GPM |
| | TAIWAN-19987 | | TAIWAN |
|  | DSA-19988 | PERA FRENO 4P RENAULT CLIO II - KANGOO - TWINGO | TAIWAN |
| | 219-988 | | KTC |
|  | TAIWAN-19998 | PERA FRENO 2P CHEVROLET AVEO-OPTRA-MATIZ- SPARK 08-11-EPICA | TAIWAN |
|  | TAIWAN-19999 | PERA FRENO 4C HYUNDAI I10-STAREX-SANTAFE-TUCSON-ACCENT 05-11-VERACRUZ-KIA RIO-FORTE-SOUL-SPORTAGE 13 | TAIWAN |
|  | 219-983-E | PERA FRENO 3P DODGE JOURNEY (56029473AC) | KTC |
|  | 219-024 | PERA MOTOVENTILADOR MAZDA 85-90G 121-323-626 | KTC |
| | E508-18-840A | | TAIWAN |
|  | 219-025 | PERA MOTOVENTILADOR NISSAN SENTRA 86-90- PRIMERA 90-96-PULSAR 86-90-SUNNY B12 | KTC |
|  | DSA-37380 | PERA MOTOVENTILADOR RENAULT 4-6-12 82-72° | TAIWAN |

| | | | |
|---|--------------|---|------------------|
|  | TAIWAN-19026 | PERA MOTOVENTILADOR 2P CHEVROLET SPRINT | TAIWAN |
|  | TAIWAN-19027 | PERA MOTOVENTILADOR CHEVROLET SWIFT 1.0-1.3 ROSCA 16MM | TAIWAN |
| | 219-027 | | KTC |
|  | TAIWAN-19028 | PERA MOTOVENTILADOR CHEVROLET SWIFT 1.6-VITARA - BALENO ROSCA 18MM | TAIWAN |
| | 219-028 | | KTC |
| | 219-079 | PERA MOTOVENTILADOR CHEVROLET STEEM - GREAT WALL | KTC |
|  | MG-04-01263 | PERA REVERSA 2P NISSAN PATROL-MITSUBISHI-SUBARU *UNIVERSAL (12321850 12326981 25320A6900 25320H1000 25320H5001 3532089910 682140051 MB113081) | GENUINE PARTS |
|  | 219-031 | PERA REVERSA 2P CAJA SPICE -FULLER | KTC |

| | | | |
|---|--------------|---|---------------|
|  | 219-032 | PERA REVERSA 2P HYUNDAI ACCENT 94-00-ELANTRA 90-EXCEL 94-99- PONY 89-99-SONATA 88/ | KTC |
|  | 219-034 | PERA REVERSA 2P CHEVROLET LUV2300-NKR-NPR-WFR-TROOPER-DMAX-RODEO | KTC |
| | TAIWAN-19034 | | TAIWAN |
|  | DSA-19035 | PERA REVERSA 4P MAZDA 323 TODOS-MAZDA 626 83-92-FORD PROBE 90-92 | TAIWAN |
|  | 219-038 | PERA REVERSA 2P MAZDA B2600 87-99-B2200 92-93-323 96/-MX5 98/ | KTC |
|  | 219-040 | PERA REVERSA 2P MITSUBHI L200-L300 | KTC |
|  | 219-041 | PERA REVERSA 2P MONTERO TODOS-PAJERO 83-90-WAGON 83-90-PICK UP 86/-SHOGUN | KTC |
|  | MG-04-01265 | PERA REVERSA 2P NISSAN PATROL - SUBARU UNIVERSAL (2532075A0E, 25320D1800, 3200570E2A, 83311AA010, 83311AA011, 8941187540, 8941187541, 8943629300, 94118754, 94362930, 1953659, 253200T000, 2532021P00, 1240552) | GENUINE PARTS |

| | | | |
|---|--------------|---|--------|
|  | 219-043 | PERA REVERSA 2P NISSAN SENTRA-FRONTIER (05-10)-XTERRA (05-10)-PATHFINDER-PRIMERA-SUNNY-TERRAN | KTC |
|  | 219-044 | PERA REVERSA 2P SPRINT 85-88-SA413-SA310-ST413 | KTC |
|  | 219-045 | PERA REVERSA 2P SUZUKI LJ80-SJ413 85/-CARRY ST30 79-85 | KTC |
|  | DSA-19047 | PERA REVERSA 2P SUZUKI SJ413 - SAMURAI- VITARA 90/-JIMMY-GRAND VITARA | TAIWAN |
| | 219-047 | | KTC |
|  | 219-048 | PERA REVERSA 2P SWIFT 1.0-1.3 84-94- SPRINT M-N - ALTO 94-02-STEMM 98/-BALENO 95/ | KTC |
|  | 219-085- | PERA REVERSA 2P TOYOTA HILUX 89-94-4RUNNER 89-01-CAMRY 91-04-COROLLA 87-04-RAV4 98-01 | KTC |
|  | 219-104 | PERA REVERSA 2P HYUNDAI H100- STAREX- ATOS SANTRO-H200 | KTC |
| | TAIWAN-19104 | | TAIWAN |
|  | 219-119 | PERA REVERSA 2P HYUNDAI TUCSON-ACCENT-ELANTRA-KIA SPORTAGE-SPECTRA-OPTIMA | KTC |

| | | | |
|---|--------------|---|---------------|
|  | 219-130 | PERA REVERSA 2P NHR- NKR55 - NQR NUEVOS MODELOS (8971659470) | KTC |
|  | TAIWAN-1936 | PERA REVERSA 2P CHEVROLET SPARK M200-M250 - MATIZ 05/ (96314357) | TAIWAN |
| | 219-136 | | KTC |
|  | 219-137 | PERA REVERSA 2P CHEVROLET SAIL (9068034) | KTC |
|  | MG-04-01327 | PERA REVERSA 2P CHEVROLET DMAX-TOYOTA-CHEVROLET | GENUINE PARTS |
|  | 90482454 | PERA REVERSA DAEWOO-AVEO-CORS | TAIWAN |
|  | TAIWAN-19995 | PERA REVERSA LOGAN-CLIO I II-TWI-SCPERA REVERSO 2P LOGAN-SANDERO-CLIO II-III-KANGOO-TWINGO-SCENIC-FLUENCE-LAGUNA (95507458) | TAIWAN |
| | 219-995 | | GPM |





| | | | |
|---|--------------|---|---------------|
|  | TAIWAN-19997 | PERA REVERSA 2P CLIO I - TWINGO - MEGANE - LOGAN | TAIWAN |
| | MG-04-01279 | PERA REVERSA 2P CHEVROLET | GENUINE PARTS |
|  | 219-134 | PERA TEMPERATURA 3P H1-H100-PORTER-TERRACAN-KIA FRONTIER-PREGIO-CERATO (39220-42700) | KTC |
|  | 219-051 | PERA TEMPERATURA 2P AVEO 1.4 -OPTRA 1.6-CIELO-RACER-SILVERADO 99-03-SIERRA-99-03 | KTC |
|  | 219-053 | PERA TEMPERATURA 2P CANTER 4D31 4D34- MIT. G11B-12B-G32B-62B-63B- DODGE RAM PICK UP 83-85(MD005051) | KTC |
|  | DSA-19056 | PERA TEMPERATURA 1P LUV 1600-DMAX-NHR-NKR-NPR-WFR | TAIWAN |
| | 219-056- | | KTC |
|  | TAIWAN-19057 | PERA TEMPERATURA LUV 2300-TROOPER-CHEVROLET | TAIWAN |

| | | | |
|---|--------------|--|--------|
|  | 219-057 | AMIGO 88/-RODEO 90 | KTC |
|  | 219-059 | PERA TEMPERATURA MAZDA 323 INJ.-MX3-MX5-MX6-B2200i 92-93-PROTEGE 00-03 | KTC |
|  | TAIWAN-19060 | PERA TEMPERATURA MAZDA 323/626/B2000/FESTIVA | TAIWAN |
|  | 219-061 | PERA TEMPERATURA MAZDA MAZDA B2000- B2600 INJ-E2000 | KTC |
|  | DSA-19063 | PERA TEMPERATURA NISSAN SENTRA B12-PATHFINDER 89-95-ALTIMA 92/-D21 86-94-SUNNY 84-93 | TAIWAN |
| | 219-063 | | KTC |
|  | 219-064 | PERA TEMPERATURA 1P SPRINT-SWIFT-SUPER CARRY-SAMURAI-TICO | KTC |
| | DSA-19064 | | TAIWAN |
|  | 219-066 | PERA TEMPERATURA 2P SWIFT 1.6/VITARA 1.6i/MAZDA B2600(1365084101) | KTC |

| | | | |
|---|---------|---|-----|
|  | 219-067 | PERA TEMPERATURA 1P TOYOTA RUNNER-CAMRY-CELICA-COROLLA-TERCEL | KTC |
|  | 219-068 | PERA TEMPERATURA TOYOTA HILUX - BURBUJA 4.5 | KTC |
|  | 219-073 | PERA TEMPERATURA MITSUBISHI GALANT - LANCER - MIRAGE - SPACE(MD177572) | KTC |
|  | 219-074 | PERA TEMPERATURA 1P NISSAN SENTRA - SUNNY - FRONTIER - MAXIMA | KTC |
|  | 219-077 | PERA TEMPERATURA 1P TOYOTA PRADO-4 RUNNER-CAMRY-CARINA-CELICA-COROLLA-LAND CRUISER-TACOMA-TERCEL-TUNDRA | KTC |
|  | 219-078 | PERA TEMPERATURA 1P MATIZ - OPTRA 1.8 - LANOS 97-02-LEGANZA 97-02-NUBIRA 97/-REZZO 00/-TACUMA 00/ | KTC |
|  | 219-082 | PERA TEMPERATURA 2P HYUNDAI ACCENT 1.3-1.3i-1.5i-1.5i 94-00-ELANTRA 95-00-EXCEL 94-99-TIBURON 99/ | KTC |

| | | | |
|---|-----------|---|--------|
|  | 219-100 | PERA TEMPERATURA 2P TOYOTA COROLLA 04/- HIGHLANDER-LAND CRUISER 3.0-4.0 03/RAV4 03/YARIS 06/LEXUS IS250(8942206010) | KTC |
|  | 219-102 | PERA TEMPERATURA 3P TOYOTA 4RUNNER 96-00- CAMRY 94-01-CELICA 94-98-COROLLA 93-97-T100 94- 98(8942222030) | KTC |
|  | 219-105 | PERA TEMPERATURA 3P HYUNDAI ACCENT 06-09-ATOS- SANTAFE-TUCSON -ELANTRA 01-09-KIA SPORTAGE 05-09- RIO 06- | KTC |
|  | 219-132 | PERA TEMPERATURA 2P NPR - NQR REWARD (8982602570) | KTC |
|  | DSA-19990 | PERA TEMPERATURA 3P LOGAN-SANDERO-TWINGO- CLIO II-KANGOO-MEGAN-SYMBOL | TAIWAN |
|  | 231-001 | PERA VÁLVULA DIESEL 12V SELENOIDE | KTC |

| | | | |
|---|--------------|--|---------------|
|  | MG-04-01185 | PILOTO PLÁSTICO LED UNIVERSAL ROJO 12V 2P | GENUINE PARTS |
|  | DSA-14020202 | PILOTO PLÁSTICO LED UNIVERSAL ROJO 12V 2P | TAIWAN |
|  | DSA-14020201 | PILOTO PLÁSTICO LED UNIVERSAL VERDE 12V 2P | TAIWAN |
|  | DSA-14020204 | PILOTO PLÁSTICO LED UNIVERSAL AZUL 12V 2P | TAIWAN |
|  | 222002-DS | PITO 12V 65MM TIPO DISCO CARRO - MOTO NEGRO UNIDAD | TAIWAN |
| | 222-002 | | KTC |
|  | 222018-DS | PITO DISCO 12V GRAVE/AGUDO 91MM ROJO-NARANJA - | TAIWAN |

| | | | |
|---|--------------|---|--------|
|  | 222-018 | (JGOX2) | KTC |
|  | 222006-DS | PITO DISCO 12V GRAVE/AGUDO 95MM CROMADO (JGOX2) | TAIWAN |
| | 222-006 | | KTC |
|  | 222-022 | PITO DISCO 12V NEGRO 76MM JGOX2 | KTC |
| | 222-016 | PITO DISCO 12V TONO ALTO 92MM ROJO X UNIDAD | KTC |
| | DSA-22016 | | TAIWAN |
|  | 1031008 | PITO DISCO 12V TONO ALTO 95MM (UND) | CAMEL |
|  | TAIWAN-22003 | PITO DISCO 12V 95MM CROMADO (JGOX2) | TAIWAN |

| | | | |
|---|---------------|--|--------|
|  | 222-003 | PITO DISCO 24V 50MM CROMADO (JGOX2) | KTC |
|  | 222-001 | PITO TIPO OREJA DE PERRO 12V NEGRO + ELEVADOR (JGOX2) | KTC |
|  | 222-021 | PITO TIPO OREJA DE PERRO 12V 80MM NEGRO + ELEVADOR (JGOX2) | KTC |
|  | HOR-33431-12V | PITO TIPO OREJA DE PERRO ROJA + ELEVADOR TIPO HELLA | TAIWAN |
|  | 222-004 | PITO REVERSA MINI 12V CHICHARRA ROJA PLÁSTICA | KTC |

| | | | |
|--|-------------|--|--------|
|  | 307-001-12V | PITO REVERSA BEE-BEE CON LUZ 12V 1PC | KTC |
|  | TAIWAN-7004 | SIRENA 12V BEE-BEE 12V 10W PEQUEÑA | TAIWAN |
|  | 222000601 | SIRENA 12V 6 TONOS 25W GRANDE | TAIWAN |
|  | 222-014 | PITO - ALARMA REVERSA 8V-60V 110dB TIPO PESADO | KTC |
|  | 222-020 | PITO - ALARMA REVERSA 12V-60V- 102dB TIPO PESADO | GPM |

| | | | |
|---|--------------|---|---------------|
|  | TAIWAN-21297 | PITO - ALARMA REVERSA 12V-24V 105dB TIPO PESADO | TAIWAN |
|  | CM21298 | PITO - ALARMA REVERSA 12V-24V TIPO PESADO | GENUINE PARTS |
|  | 304-PMA-18 | PLUMILLA AERODINAMICA 18" UND 8 ADAPTADORES | KTC |
| | 304-PMA-20 | PLUMILLA AERODINAMICA 20" UND 8 ADAPTADORES | KTC |
| | 304-PMA-22 | PLUMILLA AERODINAMICA 22" UND 8 ADAPTADORES | KTC |
| | 304-PMA-26 | PLUMILLA AERODINAMICA 26" UND 8 ADAPTADORES | KTC |
|  | 304-PMT-14 | PLUMILLA METÁLICO KTC 14" (1' 500.000 CICLOS) | KTC |
| | 304-PMT-16 | PLUMILLA METÁLICO KTC 16" (1' 500.000 CICLOS) | KTC |
| | 304-PMT-18 | PLUMILLA METÁLICO KTC 18" (1' 500.000 CICLOS) | KTC |
| | 304-PMT-22 | PLUMILLA METÁLICO KTC 22" (1' 500.000 CICLOS) | KTC |
| | 304-PMT-24 | PLUMILLA METÁLICO KTC 24" (1' 500.000 CICLOS) | KTC |
| | 304-PMT-26 | PLUMILLA METÁLICO KTC 26" (1' 500.000 CICLOS) | KTC |
| | 520000620-16 | PLUMILLA METÁLICA 16" JGOX2 TIPO B *8 ADAPTADORES | TAIWAN |
| | 52000622-18 | PLUMILLA METÁLICA 18" JGOX2 TIPO B *8 ADAPTADORES | TAIWAN |

| | | | |
|--|-------------|---|--------|
| | 52000624-20 | PLUMILLA METÁLICA 20" JGOX2 TIPO B *8 ADAPTADORES | TAIWAN |
| | 52000626-22 | PLUMILLA METÁLICA 22" JGOX2 TIPO B *8 ADAPTADORES | TAIWAN |
|  | 238-011 | POLEA 7C NISSAN FRONTIER 2.5-NAVARA 2.5-PICK UP D22-CABSTAR (24-83291) | KTC |
|  | 238-017 | POLEA 6C RENAULT CLIO-LOGAN-MEGAN-KANGOO-SYMBOL-SCENIC-LAGUNA (7700110616) | KTC |
|  | 238-022 | POLEA 7C TOYOTA HILUX- VIGO-RAV4-YARIS-COROLLA-AVENSIS (24-82310) | KTC |
|  | INR-724V | PORTADIODO HERRADURA ALTERNADOR SPRINT-SWIFT-CHEVROLET-TOYOTA 4RUNNER (INR724) (31-8200) | TAIWAN |
| | 224-29 | | KTC |

| | | | |
|---|-------------------|--|---------------|
|  | <p>224-116</p> | <p>PORTADIODO HERRADURA NISSAN SENTRA- PATHFINDER-D21-PULSAR-720-510-310-SUBARU BRAD- STANDARD *IHR722</p> | <p>KTC</p> |
|  | <p>DR-9411-OP</p> | <p>PORTADIODO HERRADURA ALTERNADOR SPARK-7.24 70AMP</p> | <p>TAIWAN</p> |
|  | <p>224-46</p> | <p>PORTADIODO HERRADURA ALTERNADOR (IHR723HD) CHEVROLET NPR-NKR-KIA SPORTAGE-TUCSON- (31- 8113)</p> | <p>KTC</p> |
|  | <p>224-80</p> | <p>PORTADIODO HERRADURA ALTERNADOR (INR424) HONDA CRV-TOYOTA 130AMP</p> | <p>KTC</p> |
|  | <p>224-81</p> | <p>PORTADIODO HERRADURA ALTERNADOR (INR5028) TOYOTA HILUX-CHEVROLET TROOPER-TACOMA- ESTEEM</p> | <p>KTC</p> |

| | | | |
|---|----------------|---|--------|
|  | 224-92 | PORTADIODO HERRADURA ALTERNADOR (INR438) TOYOTA HILUX 05/-HIACE 04-07-YARIS II | KTC |
|  | 224-93 | PORTADIODO HERRADURA ALTERNADOR (INR430) TOYOTA RAV4 - COROLLA | KTC |
|  | TAIWAN-1040-K | PORTADIODO HERRADURA ALTERNADOR FORD | TAIWAN |
|  | 224-38 | PORTADIODO (DR5176) 21-22SI KODIAK-INTERNATIONAL- NAVISTAR-CUMMINS (31-115) | KTC |
|  | 224-5 | PORTADIODO PEINE ALTERNADOR INTERNATIONAL - KODIAK 17SI- 21SI- 22SI- 23SI 33SI- 34SI (DR5173) (31-106) | KTC |
| | TAIWAN-5173-PF | | TAIWAN |
|  | DR-5040-P | PORTADIODO PEINE ALTERNADOR (DR5040) 10-20-30SI C10-C30-C70 INTERNATIONAL - JOHN DEERE | TAIWAN |

| | | | |
|---|----------|---|-----|
|  | 224-75 | CATERPILLAR TIPO DELCO (31-101) | KTC |
|  | 223-138 | PORTAESCOBILLAS ALTERNADOR NI TABLEROYARIS-HYUNDAI SANTAFE-SONATA-VERACRUZ-KIA SEDONA-SORENTO (39-8213) | KTC |
|  | 223-3 | PORTAESCOBILLAS ALTERNADOR CHEVROLET C-30 (39-101) | KTC |
|  | 223-7 | PORTAESCOBILLAS ALTERNADOR ND CHEVROLET-HONDA- TOYOTA- CHEVROLET INB220 (39-8200) | KTC |
|  | 223-8 | PORTAESCOBILLAS ALTERNADOR 15SI TYPE 116- 19SI-21SI SERIES (39-104) | KTC |
|  | 223-12-1 | PORTAESCOBILLAS ALTERNADOR CORSA INJECTION GAS- SILVERADO- BLAZER- CHEYENNE- TAHOE (39-112) | KTC |

| | | | |
|---|-----------|--|--------|
|  | 223-12-2 | PORTAESCOBILLAS ALTERNADOR DAEWOO CIELO-ESPERO- LANOS- SATURN-BLAZER-CHEYENNE CS121D (39-111) | KTC |
|  | DSA-2313 | PORTAESCOBILLAS ARRANQUE DE 28MT - FORD 7000 (69-8400)(8X25X20) | TAIWAN |
| | 223-13-E | | GPM |
|  | 223-14E | PORTAESCOBILLAS ARRANQUE DE 37MT 41MT (SIN ESCOBILLAS) (69-108) (10X29X24} | GPM |
|  | 223-14-1 | PORTAESCOBILLAS ARRANQUE DE 37MT 41MT (CON ESCOBILLAS) (69-108) (10X29X24) | KTC |
|  | DSA-23152 | PORTAESCOBILLAS ARRANQUE DE 42MT-BRIGADIER-FREIGHTLINER-MACK-KENWORTH (SIN ESCOBILLAS)(63-100) | TAIWAN |

| | | | |
|---|-------------|---|--------|
|  | 223-15-2-E | 103) | KTC |
|  | TAIWAN-2319 | PORTAESCOBILLAS ARRANQUE HI NISSAN- INFINITI- CORSIA DIESEL (69-8118) | TAIWAN |
|  | 223-20 | PORTAESCOBILLAS ARRANQUE MI DAEWOO (PLÁSTICO)- MATSURI- NISSAN- SUBARU (69-8320) 5X14.5X12 | KTC |
| | 22320-DS | | TAIWAN |
|  | TAIWAN-2321 | PORTAESCOBILLAS ARRANQUE NI TOYOTA CHEVROLET TRUCK- HINO- DAIHATSU DELTA-JOHN DEERE (69- 8203)(8X25X20) | TAIWAN |
| | 223-21 | | KTC |
|  | 223-24 | PORTAESCOBILLAS ARRANQUE FO FORD VANS- F-150- | KTC |

| | | | |
|---|----------|--|--------|
|  | 22324-DS | F350- EXPLORER (69-201-2)4.5X16X14 | TAIWAN |
|  | DSA-2326 | PORTAESCOBILLAS ARRANQUE MI KIA-NISSAN-MAZDA-SUZUKI-SUBARU-ATOS (5*10.8*12.5) | TAIWAN |
| | 223-26 | | KTC |
|  | 223-27 | PORTAESCOBILLAS ARRANQUE CORSA- R-9 INYECTION-TWINGO- FORD FIESTA- VW GOL 1.8L BOSCH | KTC |
| | DSA-2328 | PORTAESCOBILLAS ARRANQUE MATSURI- JEEP CHEROKEE- KIA RIO (69-8308) | TAIWAN |
|  | 223-29 | PORTAESCOBILLAS ARRANQUE MATSURI-323-626-SENTRA-FRONTIER-ELANTRA-HILUX(PLÁSTICO)(69-8318)4.5X12X12.2 | KTC |
| | 22329-DS | | TAIWAN |
|  | DSA-2330 | PORTAESCOBILLAS ARRANQUE MI MAZDA TURBO (69- | TAIWAN |

| | | | |
|---|-------------|--|--------|
|  | 223-30 | 8325) | KTC |
|  | 223-30-1 | PORTAESCOBILLAS ARRANQUE MI MAZDA T-CANTER- L200-300-HYUNDAI H1-H100-NISSAN KING (69-8302) 6.8X18X18 | KTC |
|  | 223-43 | PORTAESCOBILLAS ARRANQUE NI CHEVROLET LUV 2300- TOYOTA LAND CRUISER-22R- HONDA (69-8206)(7X16X15) | KTC |
| | TAIWAN-2343 | | TAIWAN |
| | DSA-2345 | PORTAESCOBILLAS ARRANQUE NI TOYOTA HILUX 4.5- VIGO -COROLLA-CAMRY- D.RAM (69- 8213)(4.2X7.5X8.4X15) | TAIWAN |
| | 223-45 | | KTC |
| | 223-48 | PORTAESCOBILLAS ARRANQUE RENAULT DUSTER- TWINGO- CLIO- SYMBOL- LOGAN- MEGANE- SUPER CARRY (69-9409) 6.5X8X11 | KTC |
| | TAIWAN-2348 | | TAIWAN |

| | | | |
|---|-------------|---|--------|
|  | TAIWAN-2349 | PORTAESCOBILLAS ARRANQUE DE PG260D PMGR AVEO-OPTRA- ASTRA-CAVALIER-DAEWOO (69-119)(5X15X12.5) | TAIWAN |
| | 223-50 | PORTAESCOBILLAS ARRANQUE DE PG150- PG260F1-CHEVROLET AVEO- OPTRA- CENTURY (69-113) (5X15X11) | KTC |
| | TAIWAN-2350 | | TAIWAN |
| | 223-53 | PORTAESCOBILLAS ARRANQUE VW JETTA- A3- BMW-NISSAN (1004336200) 5X12X11.5 | KTC |
| | 223-54 | PORTAESCOBILLAS ARRANQUE MI NISSAN- INFINITI MAZDA (69-8317) | KTC |
|  | 223-55 | PORTAESCOBILLAS ARRANQUE AGRALE-FORD CARGO-MERCEDES-VW-RENAULT (35258637)8X19X18 | KTC |







| | | | |
|--|-------------|--|--------|
|  | 223-56 | PORTAESCOBILLAS ARRANQUE LU FORD TRACTOR- JCB- PERKINS (69-9200) 9X20X24.5 | KTC |
|  | 223-62 | PORTAESCOBILLAS ARRANQUE MITSUBISHI CANTER M/N- MAZDA B2600- NISSAN TITAN (69-8341)7X12X17.5 | KTC |
| | TAIWAN-2362 | | TAIWAN |
|  | TAIWAN-2364 | PORTAESCOBILLAS ARRANQUE MITSUBISHI MAZDA 323- 626- NISSAN- KIA- FORD FESTIVA- MONTERO (3 ESC.) (69- 8315) | TAIWAN |
|  | 223-71 | PORTAESCOBILLAS ARRANQUE BO CHEVROLET CHEVETTE- MONZA- FORD SIERRA- FIAT (9001082518) | KTC |
|  | TAIWAN-2372 | PORTAESCOBILLAS ARRANQUE VA HYUNDAI-KIA 10-16 METALLICO 5x10.8x12.5 (3617-02500) 5X10X13 | TAIWAN |

| | | | |
|---|-------------|---|--------|
|  | 223-73 | PORTAESCOBILLAS ARRANQUE DAEWOO MATIZ- RACER- KIA RIO (4.6X13X12) | KTC |
|  | TAIWAN-2377 | PORTAESCOBILLAS ARRANQUE MAZDA BT50 323-626- NISSAN SENTRA- FRONTIER-SCAPE-COROLLA-HILUX (69-8313-3) | TAIWAN |
|  | 223-79 | PORTAESCOBILLAS ARRANQUE MI CHEVROLET SPARK- CRONOS-HYUNDAI-KIA (4X13X11.5) | KTC |
| | TAIWAN-2379 | | TAIWAN |
|  | DSA-2383 | PORTAESCOBILLAS ARRANQUE MI HYUNDAI SANTAFE- MAZDA BT50-3-6-SPARK-CRONOS-MITSUB (69-8322) 4.5X12X12.2 | TAIWAN |
| | 223-83 | | KTC |
|  | DSA-2384 | PORTAESCOBILLAS ARRANQUE MI URBAN 2.5L-ALTIMA- QUEST-JEEP-SUBARU (69-8334) 4.5X12X12.5 | TAIWAN |
| | 223-84 | | KTC |

| | | | |
|---|--------------|--|--------|
|  | 223-85-1 | PORTAESCOBILLAS ARRANQUE HYUNDAI H-100 DIESEL- STAREX -SPRINTER (KIT) 7X14X14 | KTC |
| | TAIWAN-2390 | PORTAESCOBILLAS ARRANQUE RENAULT 9 FULL INJECTION | TAIWAN |
|  | DSA-2392 | PORTAESCOBILLAS ARRANQUE BO LUV 2300 RELACION- CORSA GASOLINA- R-9 INY- NISSAN D21- VW (69-9121) 5 | TAIWAN |
| | 223-92 | | KTC |
|  | TAIWAN-23110 | PORTAESCOBILLAS ARRANQUE BO LUV 2300- R-9- SWIFT- ASTRA-ZAFIRA-PALIO-VECTRA-(1004336957) | TAIWAN |
| | 223-110 | | KTC |
|  | 223-111 | PORTAESCOBILLAS ARRANQUE BO TOYOTA HILUX VIGO ESCOBILLA PEQUEÑA (5x12x11.5) | KTC |

| | | | |
|---|--------------|---|--------|
|  | 223-112 | PORTAESCOBILLAS ARRANQUE BO TOYOTA VIGO-VW BORA ESCOBILLA BAJITA (5x12x11.5) | KTC |
| | TAIWAN-23113 | PORTAESCOBILLAS ARRANQUE BO TOYOTA HILUX- VIGO ESCOBILLA ALTA- VW- AUDI (6X14X18) | TAIWAN |
| | 223-113 | | KTC |
|  | 223-114 | PORTAESCOBILLAS ARRANQUE BO TOYOTA VIGO-CHEV.VAN-MERCEDES BENZ-BERLINGO (4.5X10X13) | KTC |
|  | TAIWAN-23116 | PORTAESCOBILLAS ARRANQUE DE PG260 CORSA EVOLUTION NISSAN (CABLE LARGO) (69-127) | TAIWAN |
|  | 223-119 | PORTAESCOBILLAS ARRANQUE KIA PICANTO (7.5X10X17) | KTC |

| | | | |
|---|--------------|---|--------|
|  | 223-126 | PORTAESCOBILLAS ALTERNADOR ND TOYOTA VIGO-LEXUS- HONDA ACURA-DODGE-JEEP-HYUNDA-KIA (39-8206) | KTC |
|  | 223-127 | PORTAESCOBILLAS ARRANQUE NPR REWARD-NQR-DMAX-NISSAN TD27-FRONTIER GIRO IZQUIERDO (2240-4310)7X19X16 | KTC |
|  | DSA-23128 | PORTAESCOBILLAS ARRANQUE HYUNDAI I10-GRAND I10-KIA PICANTO | TAIWAN |
|  | DSA-23129 | PORTAESCOBILLAS ARRANQUE FORD TRITON-LOBO V6-PG150-150S-260F1-260G (69-113-1) | TAIWAN |
|  | TAIWAN-23136 | PORTAESCOBILLAS ARRANQUE BO DUSTER-MEGANE | TAIWAN |

| | | | |
|---|-------------|--|--------|
|  | 223-136 | FASE 2- SANDERO 4.4X8.5X11 (6003940125) | KTC |
|  | 223-140 | PORTAESCOBILLAS ARRANQUE BO T. HILUX 20-MER. 709-710-712-809-812-814-912-I. DAILY 6X18X14.5(69-9168) | KTC |
|  | 240-002 | PORTAFUSIBLE ELECTRÓNICO ATO CON TAPA PLÁSTICO AWG14 CABLE CONTINUO | KTC |
|  | TAIWAN-4002 | PORTAFUSIBLE ELECTRÓNICO ATO CON TAPA PLÁSTICO AWG14 CABLE SEPARADO | TAIWAN |
|  | 240-005 | PORTAFUSIBLE ELECTRÓNICO ATO ENCAUCHETADO ROJO AWG14 | KTC |
| | SQ-080-DS | | TAIWAN |
|  | SQ-101-A | PORTAFUSIBLE ELECTRÓNICO ATO LOZA CON TAPA | TAIWAN |
| | 240-004 | | KTC |

| | | | |
|---|-------------|---|--------|
|  | 240-016 | PORTAFUSIBLE ELECTRÓNICO ATO NEGRO PARA ARMAR | KTC |
|  | 240-008 | PORTAFUSIBLE ELECTRÓNICO MAXI | KTC |
| | TAIWAN-4008 | | TAIWAN |
|  | SQ-1090 | PORTAFUSIBLE ELECTRÓNICO MAXI | TAIWAN |
| | 240-013 | PORTAFUSIBLE ELECTRÓNICO ATO MINI CON TAPA ENCAUCHETADO | KTC |
|  | SQ-020 | PORTAFUSIBLE VIDRIO ROSCA AÉREO | TAIWAN |

| | | | |
|---|---------------------|--|----------------------|
|  | <p>TAIWAN-66329</p> | <p>PROBADOR DE CORRIENTE METÁLICO 6-24V PEQUEÑO DORADO</p> | <p>TAIWAN</p> |
|  | <p>CA86044</p> | <p>PROBADOR DE CORRIENTE PLÁSTICO 6-24V GRANDE</p> | <p>TAIWAN</p> |
|  | <p>235-215</p> | <p>PROTECTOR TERMINAL TIPO AMERICANO COLORES</p> | <p>KTC</p> |
|  | <p>235-022</p> | <p>PROTECTOR TERMINAL TIPO AMERICANO TRANSPARENTE</p> | <p>KTC</p> |
|  | <p>MG-03-05011</p> | <p>CONTACTO IGNICIÓN DAEWOO 6 PINES</p> | <p>GENUINE PARTS</p> |

| | | | |
|---|--------------------|--|----------------------|
|  | <p>MG-03-05010</p> | <p>CONTACTO IGNICIÓN DAEWOO 5 PINES (S11370415)</p> | <p>GENUINE PARTS</p> |
|  | <p>253-011</p> | <p>CONTACTO IGNICIÓN 6C HYUNDAI ACCENT-SANTAFE-VERACRUZ-KIA RIO-OPTIMA-MAGENTIS (931103K000)</p> | <p>KTC</p> |
|  | <p>253-013</p> | <p>CONTACTO IGNICIÓN 7C FORD FIESTA-FOCUS-FUSION-BMAX-GALAXY-MONDEO (1062207)</p> | <p>KTC</p> |
|  | <p>DSA-1419001</p> | <p>CONTACTO IGNICIÓN CHEVROLET AVEO-OPTRA-MATIZ-DAEWOO LANOS-NUBIRA *6 PINES (96238726 - 51015 - 3711186Z00)</p> | <p>TAIWAN</p> |
| | <p>GPM-001</p> | | <p>GPM</p> |
| | <p>MG-03-05012</p> | | <p>GENUINE PARTS</p> |
| | <p>GPM-027</p> | <p>CONTACTO IGNICIÓN CHEVROLET SAIL-CORSA-ASTRA-VECTRA-OMEGA-TIGRA</p> | <p>GPM</p> |

| | | | |
|---|-------------|--|------------------|
| | MG-03-05013 | VECTRA-OMEGA-TIGRA *6 PINES (90505912 - 0914856) | GENUINE PARTS |
|  | GPM-032 | CONTACTO IGNICIÓN CHEVROLET SPARK *6 PINES | GPM |
|  | MG-03-05016 | CONTACTO IGNICIÓN CHEVROLET ASTRA-CORSA- CORSA *5 PINES (90052497) | GENUINE PARTS |
|  | MG-03-02011 | RAMAL SWITCH IGNICIÓN CHEVROLET CLIO - RENAULT SANDERO - LOGAN *4 PINES (84141-L) | GENUINE PARTS |
|  | MG-03-10002 | RAMAL SWITCH IGNICIÓN CHEVROLET SWIFT 4 PINES (84450-87306) | GENUINE PARTS |

| | | | |
|---|--------------------|--|----------------------|
|  | <p>MG-03-08010</p> | <p>RAMAL SWITCH IGNICIÓN CHEVROLET LUV 1600</p> | <p>GENUINE PARTS</p> |
|  | <p>253-024</p> | <p>RAMAL SWITCH IGNICIÓN 4C+2C CHEVROLET DMAX 07/ (8973500720)</p> | <p>KTC</p> |
|  | <p>MG-03-08018</p> | <p>RAMAL SWITCH IGNICIÓN CHEVROLET D-MAX *4+2 PINES (8973500720)</p> | <p>GENUINE PARTS</p> |
|  | <p>MG-03-08009</p> | <p>RAMAL SWITCH IGNICIÓN CHEVROLET NKR - TFT- KS (8944344433)</p> | <p>GENUINE PARTS</p> |

| | | | |
|---|--------------------|---|----------------------|
|  | <p>MG-03-08013</p> | <p>RAMAL SWITCH IGNICIÓN CHEVROLET NPR (8970882680)</p> | <p>GENUINE PARTS</p> |
|  | <p>MG-03-08008</p> | <p>RAMAL SWITCH IGNICIÓN CHEVROLET NPR/NKR (894127779251 - 893970141184 - 8943422230)</p> | <p>GENUINE PARTS</p> |
|  | <p>MG-03-08014</p> | <p>RAMAL SWITCH IGNICIÓN CHEVROLET NPR/NKR</p> | <p>GENUINE PARTS</p> |
|  | <p>MG-03-05007</p> | <p>RAMAL SWITCH IGNICIÓN DAEWOO</p> | <p>GENUINE PARTS</p> |

| | | | |
|---|--------------------|---|--------------------------|
|  | <p>MG-03-02002</p> | <p>RAMAL SWITCH IGNICIÓN RENAULT 9 GAMA EN CRUZ +*5+4 PINES</p> | <p>GENUINE PARTS</p> |
|  | <p>GPM-002</p> | <p>RAMAL SWITCH IGNICIÓN RENAULT LOGAN-SANDERO- CLIO II</p> | <p>GPM</p> |
|  | <p>MG-03-02012</p> | <p>RAMAL SWITCH IGNICIÓN RENAULT KANGOO-TWINGO *4 PINES (84146-L)</p> | <p>GENUINE PARTS</p> |
|  | <p>MG-03-02008</p> | <p>RAMAL SWITCH IGNICIÓN RENAULT MEGANE-SCENIC</p> | <p>GENUINE PARTS</p> |
| | <p>MG-03-02001</p> | <p>RAMAL SWITCH IGNICIÓN RENAULT 9 GAMA EN Y *5+4 PINES</p> | <p>GENUINE PARTS</p> |

| | | | |
|---|--------------------|---|----------------------|
|  | <p>MG-03-09003</p> | <p>RAMAL SWITCH IGNICIÓN MAZDA 323 (B09266151 G21166151)</p> | <p>GENUINE PARTS</p> |
|  | <p>MG-03-09001</p> | <p>RAMAL SWITCH IGNICIÓN MAZDA 323 *9 PINES (BF67-66-151)</p> | <p>GENUINE PARTS</p> |
|  | <p>MG-03-09019</p> | <p>RAMAL SWITCH IGNICIÓN MAZDA 626 (G03266154C)</p> | <p>GENUINE PARTS</p> |
|  | <p>MG-03-09022</p> | <p>RAMAL SWITCH IGNICIÓN MAZDA 626 97-92 *6 PINES (3711176000)</p> | <p>GENUINE PARTS</p> |
|  | <p>MG-03-09002</p> | <p>RAMAL SWITCH IGNICIÓN MAZDA B1600/B2000 B2200/B2400 '86 - '95 *7 PINES (UB71-66-151-7P WITH ALARM BUZZER SWITCH)</p> | <p>GENUINE PARTS</p> |

| | | | |
|--|--------------------|--|--------------------------|
|  | <p>MG-03-09017</p> | <p>RAMAL SWITCH IGNICIÓN MAZDA B1600/B2000 B2200/B2400 *9 PINES (UB71-66-151-7P)</p> | <p>GENUINE PARTS</p> |
|  | <p>MG-03-06036</p> | <p>RAMAL SWITCH IGNICIÓN TOYOTA LAND CRUISER HJ611/HJ60 (8445060080)</p> | <p>GENUINE PARTS</p> |
|  | <p>MG-03-06037</p> | <p>RAMAL SWITCH IGNICIÓN TOYOTA LAND CRUISER (8445060070, 88921911, E1482)</p> | <p>GENUINE PARTS</p> |
|  | <p>MG-03-06038</p> | <p>RAMAL SWITCH IGNICIÓN TOYOTA LAND CRUISER 2F HJ47 (84450-60050/60)</p> | <p>GENUINE PARTS</p> |
|  | <p>MG-03-06026</p> | <p>RAMAL SWITCH IGNICIÓN TOYOTA HILUX RN30/40 *5 PINES (KE30/BY42 - 8445014021)</p> | <p>GENUINE PARTS</p> |

| | | | |
|---|--------------------|--|----------------------|
|  | <p>MG-03-06027</p> | <p>RAMAL SWITCH IGNICIÓN TOYOTA HILUX RN20/25 *4 PINES (KE20 - 8445012021)</p> | <p>GENUINE PARTS</p> |
|  | <p>MG-03-05018</p> | <p>RAMAL SWITCH IGNICIÓN KIA 5 PINES (UB71-66-151)</p> | <p>GENUINE PARTS</p> |
|  | <p>MG-03-05098</p> | <p>RAMAL SWITCH IGNICIÓN KIA PICANTO ION 6 (12-17) - HYUNDAI I25 - HYUNDAI ACCENT (17-12) - HYUNDAI ELANTRA GT (18-17) - KIA FORTE (18-14) - KIA FORTE KOUP (16-14) - KIA FORTE5 (18-14) (931101R000 - US1211 - 1S12044)</p> | <p>GENUINE PARTS</p> |
|  | <p>MG-03-05008</p> | <p>RAMAL SWITCH IGNICIÓN HYUNDAI (9311002000)</p> | <p>GENUINE PARTS</p> |
|  | <p>MG-03-05113</p> | <p>CONTACTO IGNICIÓN HYUNDAI H100 6 PINES (931104F000)</p> | <p>GENUINE PARTS</p> |

| | | | |
|--|-------------|---|---------------|
|  | 253-010 | RAMAL IGNICIÓN HYUNDAI ACCENT-VERNA *6 PINES | KTC |
|  | MG-03-05040 | RAMAL IGNICIÓN HYUNDAI ACCENT VERNA *6 PINES | GENUINE PARTS |
|  | MG-03-07007 | RAMAL IGNICIÓN NISSAN SENTRA (4875075Y00) | GENUINE PARTS |
|  | MG-03-05024 | RAMAL IGNICIÓN FORD FIESTA - ECOSPORT (89BF11572AB - 2S6511572AA) | GENUINE PARTS |

| | | | |
|---|--------------------|---|----------------------|
|  | <p>MG-01-07025</p> | <p>RAMAL SWITCH DIRECCIONAL KODIAK</p> | <p>GENUINE PARTS</p> |
|  | <p>225-6</p> | <p>REGULADOR ALTERNADOR (GR540) 12V UNIVERSAL FORD</p> | <p>KTC</p> |
| | <p>GR-540-M</p> | | <p>TAIWAN</p> |
| | <p>GR-540-D</p> | | <p>TAIWAN</p> |
|  | <p>DSA-IB033</p> | <p>REGULADOR ALTERNADOR 24V UNIVERSAL *IB-033 (192033001 0192033002 0192033004)</p> | <p>TAIWAN</p> |
|  | <p>DSA-P8393</p> | <p>REGULADOR 24V REGULADOR ALTERNADOR PRESTOLITE CATERPILLAR</p> | <p>TAIWAN</p> |
|  | <p>225-1</p> | <p>REGULADOR ALTERNADOR (D411HD) 12V CS130 DAEWOO- BLAZER-CHEROKEE-CENTURY HD</p> | <p>KTC</p> |



| | | | |
|---|--------|---|-----|
|  | 225-10 | REGULADOR ALTERNADOR (IB231) 12V CORSA-ASTRA-ZAFIRA-FIAT PALIO-SIENA-FORD FIESTA-SPRINTER-VW GOLF | KTC |
|  | 225-12 | REGULADOR (IB239) 12V RENAULT CLIO- MEGAN-SYMBOL- LAGUNA | KTC |
|  | 225-13 | REGULADOR ALTERNADOR (IB358) 12V VW GOL-APOLLO-VOYAGE-PARATI-SANATANA-POINTER-FIAT UNO- | KTC |
|  | 225-20 | REGULADOR (IH253) 24V ISUZU NPR-FVR | KTC |

| | | | |
|---|-------------|---|--------|
| | 225-26 | REGULADOR ALTERNADOR (IM476) 12V MAZDA BT-50-FORD RANGER- NISSAN FRONTIER-URVAN-PATHFINDER-INFINITI-NAVARA-QX4 | KTC |
|  | 225-31 | REGULADOR ALTERNADOR 12V SPRINT-SWIFT-SUZUKI-SAMURAI (35-8216) (IN251) | KTC |
| | TAIWAN-251D | | TAIWAN |
|  | 225-32 | REGULADOR ALTERNADOR (IN257) 12V TOYOTA LAND CRUISER-CAMRY-RAV4-TERCEL-COROLLA-CELICA-DAIHATSUU DELTA (35-8242) | KTC |
|  | 225-33 | REGULADOR ALTERNADOR (IN437) 12V TOYOTA LAND CRUISER-RAV4-4RUNNER-CELICA-CAMRY-TACOMA-TERCEL (35-8235) | KTC |

| | | | |
|--|------------|--|--------|
|  | 225-35 | REGULADOR ALTERNADOR (IX110) 12V MAGNETTI MARELLI MAZDA-FIAT UNO-TIPO-TEMPRA | KTC |
|  | 225-46 | REGULADOR ALTERNADOR (IM345) 12V MAZDA 323-ALLEGRO-3-5-KIA SEPHIA-MIT.PAJERO-GALANT-LANCER | KTC |
|  | 225-65-3 | REGULADOR ALTERNADOR (D2262) 12V CHEVROLET OPTRA- AVEO- SUZUKI (3 PIN) | KTC |
| | D-8055-12V | | TAIWAN |
|  | 225-74 | REGULADOR ALTERNADOR (IM832) 12V HYUNDAI ACCENT-EXCEL-SONATA-MIT.PAJERO-COLT-LANCER-GALANT (35-8336) | KTC |

| | | | |
|---|---------------|---|------------|
|  | <p>225-83</p> | <p>REGULADOR (IN6015) 12V TOYOTA VIGO-HIACE-LEXUS-HONDA ACCORD-CRV-CIVIC</p> | <p>KTC</p> |
|  | <p>225-90</p> | <p>REGULADOR ALTERNADOR (IH738) 12V NISSAN FRONTIER 2.4L-XTERRA-PATHFINDER-TERRANO-ALTIMA-URVAN-ALMERA-DMAX-NPR</p> | <p>KTC</p> |
|  | <p>225-91</p> | <p>REGULADOR ALTERNADOR (IH783) 12V CHEVROLET NPR-NQR N/M</p> | <p>KTC</p> |
|  | <p>225-92</p> | <p>REGULADOR ALTERNADOR (IM265HD) 12V MAZDA 323-626-B2000 - HYUNDAI (35-8308)</p> | <p>KTC</p> |

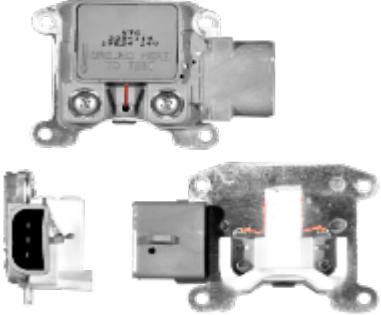

| | | | |
|---|---------|--|-----|
|  | 225-102 | REGULADOR ALTERNADOR (IY028) 12V HYUNDAI ACCENT-TUCSON-ELANTRA-KIA SPORTAGE | KTC |
|  | 225-103 | REGULADOR ALTERNADOR(M571) 12V MEGANE FASE II-SYMBOL- KANGOO - SCENIC | KTC |
|  | 225-106 | REGULADOR ALTERNADOR (IH767) 12V NPR2000-NISSAN ALMERA-SENTRA 1.6L-PRIMERA-SUNNY | KTC |
|  | 225-112 | REGULADOR ALTERNADOR (D27) 12V 20-21-22-27-33-34SI CON TORNILLO (35-105-VR182) | KTC |

| | | | |
|---|---------|---|-----|
|  | 225-113 | REGULADOR ALTERNADOR (D2206) 12V AVEO-OPTRA-SUZUKI SWIFT 1.6L 2 PINES | KTC |
|  | 225-114 | REGULADOR ALTERNADOR (F794B) FORD 150-250-350-VANS 3G-EXPLORER-RANGER-TAURUS (35-205) | KTC |
|  | 225-116 | REGULADOR (M551) 12V CORSA EVOLUTION-ASTRA-ZAFIRA-PEUGEOT-CITROEN-FIAT-RENAULT | KTC |
|  | 225-117 | REGULADOR ALTERNADOR (M546) 12V CLIO II-MEGAN II-SANDERO-SCENIC-KANGOO-LAGUNA-SPACE-PEUGEOT-CITROEN-NISSAN-VOLV | KTC |

| | | | |
|--|-------------|--|--------|
|  | 225-118 | REGULADOR ALTERNADOR 12V (M569) GETZ-IX35-SONATA-KIA PICANTO MORNING-EON 11-19 | KTC |
|  | 225-120 | REGULADOR ALTERNADOR (A5TA8192) 12V MAZDA BT50 GASOLINA MITSUBISHI | KTC |
|  | D-220007 | REGULADOR ALTERNADOR 12V OPTRA | TAIWAN |
|  | 12073501-DS | REGULADOR ALTERNADOR 12V R9 BOSCH | TAIWAN |

| | | | |
|---|-------------|---|--------|
|  | 225-152 | REGULADOR (M544-M550) HYUNDAI I10-I25- I30-N20- ACCENT-ELANTRA-GETZ-TUCSON-KIA SOUL | KTC |
|  | 225-181 | REGULADOR ALTERNADOR HYUNDAI I10 (1 PIN) PARA ALTERNADOR F000BL0118 | KTC |
|  | D-30 | REGULADOR ALTERNADOR 24V P900/GM (D-104H) | TAIWAN |
|  | CGR-800 | RESISTENCIA BOBINA CAMPERO TORNILLO | TAIWAN |
|  | TAIWAN-2023 | RESISTENCIA MOTOVENTILADOR RENAULT | TAIWAN |

| | | | |
|---|--------------|---|--------|
|  | TAIWAN-2024 | RESISTENCIA MOTOVENTILADOR CHEVROLET SONIC - TRACKER -CRUZE | TAIWAN |
|  | 94118091 | RETENEDOR ALTERNADOR NPR CAFÉ *TIPO CHEVROLET | TAIWAN |
|  | TAIWAN-55001 | SENSOR CMP EJE LEVAS AVEO 04-08-SALOON 06-11-DAEWOO KALOS-NUBIRA (96253544) | TAIWAN |
| | 255-001 | | KTC |
|  | TAIWAN-55002 | SENSOR CMP EJE LEVAS AVEO SALOON 05-DAEWOO KALOS 02-09-MATIZ 98-09-SPARK-CRONOS (93 744 875) | TAIWAN |
| | TAIWAN-55004 | SENSOR CMP EJE LEVAS HYUNDAI ATOS 98-02-GETZ-SANTAFE 01-02-SONATA-PICANTO I10-OPTIMA(39310-38050) | TAIWAN |
|  | TAIWAN-55007 | SENSOR CKP CIGÜEÑAL CORSA 1.4-1.6-ASTRA-VERSA- | TAIWAN |

| | | | |
|---|--------------|--|--------|
|  | 255-007 | ZAFIRA-FIAT PALIO1.8-SIENA (90451442) | KTC |
|  | 255-008 | SENSOR CKP CIGÜEÑAL CHEVROLET OPTRA-CAPTIVA-ISUZU-TROOPER | KTC |
| | TAIWAN-55011 | SENSOR CKP CIGÜEÑAL AVEO 04-08-AVEO 5-OPTRA 1.6L (25182450) | TAIWAN |
| | 255-011 | | KTC |
|  | TAIWAN-55012 | SENSOR CKP CIGÜEÑAL AZUL-RENAULT IZQ.LOGAN-SANDERO-CLIOIII-TWINGO-NISSAN-TIIDA-QASHQAI (82 00 643 171) | TAIWAN |
| | 255-012 | | KTC |
|  | 255-013 | SENSOR CKP CIGÜEÑAL AVEO 05-SPARK-CRONOS-MATIZ-CHERY QQ-KALOS | KTC |

| | | | |
|---|--------------|--|--------|
|  | TAIWAN-55014 | SENSOR CKP CIGÜEÑAL HYUNDAI ACCENT 00-06-VERNA-VISION-GETZ-KIA RIO-CERATO (3918022600) | TAIWAN |
| 255-014 | KTC | | |
|  | 255-015 | SENSOR CKP CIGÜEÑAL NEGRO-RENAULT IZQ.LOGAN-SANDERO-MEGANE-SYMBOLCLIOII-KANGOO-TWINGO-KUB (6001548175) | KTC |
|  | TAIWAN-55016 | SENSOR MAP BLAZER-CORSA-CHEYENNE 1500-2500-3500-CHEROKEE-TROOPER-RODEO-DAEWOO CIELO-RACER (7696064) | TAIWAN |
|  | 255-017 | SENSOR MAP CORSA-ASTRA-RODEO-TROOPER-HHR-ZAFIRA-TRAIL BLAZER-DAEWOO NUBIRA-LEGANZA (4409668) | KTC |
|  | TAIWAN-55019 | SENSOR MAP RENAULT LOGAN CLIO II-KANGOO-MEGANE-ELIANCE-TRAFIC-SCENIC-TWINGO | TAIWAN |

| | | | |
|---|--------------|---|--------|
|  | 255-019 | MEGANE-LOGAN-CLIO-TRAFIC-SCENIC-TWINGO (8200719629) | KTC |
|  | TAIWAN-55020 | SENSOR CKP CIGUEÑAL AZUL RENAULT DERECHO LOGAN 02-05-CLIOII-KANGOO-SCENIC-SYMBOL-LAGUNA (82 00 647 554) | TAIWAN |
| | 255-020 | | KTC |
|  | TAIWAN-55021 | SENSOR CKP CIGUEÑAL NEGRO RENAULT DER. CLIO- MEGANE-KANGOO-GRAN SCENIC-TRAFIC-LAGUNA (7700101970) | TAIWAN |
| | 255-021 | | KTC |
|  | 255-024 | SENSOR CKP CIGUEÑAL HYUNDAI ACCENT-I30-TUCSON | KTC |
|  | 255-025 | SENSOR CKP CIGUEÑAL CHEVROLET SAIL 10-G.V | KTC |

| | | | |
|---|--------------|---|--------|
|  | 255-076 | SENSOR CKP CIGUEÑAL HYUNDAI I10-GETZ-SANTRO-KIA PICANTO (3931002700) | KTC |
|  | TAIWAN-55046 | SENSOR TPS P. ACELERADOR CLIO 16V-MEGANE-SCENIC-SYMBOL-KANGOO-FIAT PALIO-SIENA-TEMPRA CCW (40406202) | TAIWAN |
| | 255-046 | | KTC |
|  | 255-049 | SENSOR TPS P. ACELERADOR C.TRACKER 01-04-GRAND VITARA 99-05-VITARA-ESTEEM-FORESTER-LEGACY-SERA 483-06 | KTC |
|  | 255-050 | SENSOR TPS P. ACELERADOR DMAX DIESEL 96-04-N.FRONTIER 99-04-PATHFINDER 96-00-XTERRA 00 (226204P202) | KTC |

| | | | |
|---|---------------------|---|---------------|
|  | <p>TAIWAN-55051</p> | <p>SENSOR TPS P. ACELERADOR HYUNDAI ATOS PRIME-M.MONTERO 99-04-GALANT-ECLIPSE CCW (MD628077)</p> | <p>TAIWAN</p> |
|  | <p>TAIWAN-55052</p> | <p>SENSOR TPS P. ACELERADOR AVEO FAMILY-OPTRA-SPARK-LANOS-CORSA-TROOPER-CHEYENNE-JIMMY CW (17087653)</p> | <p>TAIWAN</p> |
|  | <p>255-054</p> | <p>SENSOR OXÍGENO UNIVERSAL 2 CABLES CON ADAPTADORES (30CM) MAZDA-MITSUBISHI (250-22000) CONVENCIONAL</p> | <p>KTC</p> |
|  | <p>255-056</p> | <p>SENSOR OXÍGENO UNIVERSAL 4 CABLES ADAPTADORES (65CM) CHEVROLET-FORD-HYUNDAI-MITS-SUZUKI 258005729 CONVENCIONAL</p> | <p>KTC</p> |
|  | <p>255-059</p> | <p>SENSOR OXÍGENO 4 CABLES (30CM) HYUNDAI ACCENT-TUCSON-VERNA-KIA RIO-SOUL-SPORTAGE-SPECTRA 19107314 - PLANAR</p> | <p>KTC</p> |

| | | | |
|---|--------------|--|--------|
|  | 255-060 | SENSOR OXÍGENO 4 CABLES (49CM) AVEO-MATIZ-MAZDA 626-929-MX6 (25024067) CONVENCIONAL | KTC |
|  | 255-065 | SENSOR OXÍGENO 4 CABLES (80CM) ATOS PRIME-IX30-IX35-ACCENT-TUSCON-SANTAFE-PICANTO-RIO (39210-02600) CONVENCIONAL | KTC |
|  | 255-084 | SENSOR OXÍGENO 4 CABLES (45CM) DUSTER-LOGAN-SANDERO - PLANAR | KTC |
|  | 257-001 | SENSOR VÁLVULA IAC AVEO-OPTRA-CORSA-DAEWOO CIELO-LANOS-NUBIRA (93744675) | KTC |
| | TAIWAN-57001 | | TAIWAN |
|  | 257-004 | SENSOR VÁLVULA IAC BLAZER 4.3L TBI-S10-JIMMY-CORSA-CHEVY LUV 2200 DAEWOO RACER (17112712) | KTC |





| | | | |
|--|---------|---|-----|
| | 218-003 | SILICONA NEGRA RTV 85GR | KTC |
| | 218-001 | SILICONA ULTRA GREY - RTV 85GR BLISTER- PROTECCION SENSORES (5699) | KTC |
| | 218-002 | SILICONA TRANSPARENTE - RTV 85GR BLISTER- PROTECCION SENSORES (5699) *ULTRA GRIS | KTC |
|  | 230-107 | SOCKET ALTERNADOR CS130 AVEO - BLAZER | KTC |
|  | 230-199 | SOCKET ALTERNADOR MITSUBISHI-VALEO-MANDO | KTC |
|  | 230-117 | SOCKET ALTERNADOR NKR-NPR (IH252-IH253) | KTC |

| | | | |
|---|---------------|---|--------|
|  | TAIWAN-230108 | SOCKET ALTERNADOR TOYOTA VIGO - HONDA 4C | TAIWAN |
| 230-108 | KTC | | |
|  | 230-128 | SOCKET BOBINA CLIO-MEGAN-SYMBOL-KIA | KTC |
|  | 230-152 | SOCKET BOBINA HONDA CIVIC - CRV 05-11 | KTC |
|  | DSA-30146 | SOCKET BOBINA SPARK GT 13-16 | TAIWAN |
| 230-146 | KTC | | |
|  | 230-039 | SOCKET BOBINA HYUNDAI-KIA-GIRO-VISION DERECHA | KTC |
|  | 230-040 | SOCKET BOBINA HYUNDAI-KIA-GIRO-VISION IZQUIERDA | KTC |

| | | | |
|---|-----------|--|--------|
|  | 230-149 | SOCKET BOBINA HYUNDAI ACCENT-KIA RIO-PICANTO | KTC |
|  | 230-070 | SOCKET BOMBA GASOLINA TOYOTA 4RUNNER-YARIS-HILUX 4P | KTC |
|  | 208-610 | SOCKET BOMBA GASOLINA UNIVERSAL LARGO 240MM (C05L) 227-008 | KTC |
|  | SC-1C | SOCKET BOMBILLO 1141 CON BASE- BAQUELITA METÁLICO | TAIWAN |
|  | SC-2C | SOCKET BOMBILLO 1034 CON BASE- BAQUELITA | TAIWAN |
|  | DSA-30057 | SOCKET BOMBILLO 1034 PLÁSTICO GRIS 2 GUÍAS | TAIWAN |

| | | | |
|--|--------------|--|--------|
| | 230-139 | SOCKET BOMBILLO 1141 PLÁSTICO GRIS 2 GUÍAS | KTC |
| | TAIWAN-30138 | SOCKET BOMBILLO 1034 PLÁSTICO GRIS 2 GUÍAS | TAIWAN |
| | TAIWAN-30138 | SOCKET BOMBILLO 1034 PLÁSTICO GRIS 2 GUÍAS | TAIWAN |
| | 230-138 | | KTC |
| | SQ-215-CER | SOCKET BOMBILLO 1141 PLÁSTICO BLANCO 3 GUÍAS | TAIWAN |
| | 230-141 | | KTC |
| | TAIWAN-3061 | SOCKET BOMBILLO 1034 2 CONTACTOS 3 GUÍAS PLÁSTICO BASE CERAMICA | TAIWAN |
| | 230-140 | | KTC |

| | | | |
|---|--------------|---|---------------|
| | DSA-30056 | SOCKET BOMBILLO 1141 PLÁSTICO GRIS 4 GUÍAS | TAIWAN |
|  | DSA-30057 | SOCKET BOMBILLO 1034 PLÁSTICO GRIS 4 GUÍAS | TAIWAN |
| | 230-057 | | KTC |
|  | T-10CONCABLE | SOCKET BOMBILLO 158 ENCAUCHETADO CON GUÍAS Y BASE | TAIWAN |
| | 230-009 | | KTC |
|  | 230105-DS | SOCKET BOMBILLO 158 ENCAUCHETAD | TAIWAN |
|  | 230-010 | SOCKET BOMBILLO H4 HALÓGENO LOZA CON CABLES PARA ALTA TEMPERATURA | KTC |
|  | MG-10-01143 | SOCKET BOMBILLO H4 HALÓGENO LOZA ENCAUCHETADO | GENUINE PARTS |

| | | | |
|---|--------------|--|--------|
|  | SQ-1260-A | SOCKET BOMBILLO H4 HALÓGENO LOZA ENCAUCHETADO | TAIWAN |
|  | 230-001 | SOCKET BOMBILLO H4 HALÓGENO LOZA ENCAUCHETADO | KTC |
|  | 230-002 | SOCKET BOMBILLO H4 CURVO EN LOZA | KTC |
| | 230002-DS | | TAIWAN |
|  | 230-194 | SOCKET BOMBILLO H4 BAQUELA TIPO HELLA PASTA NEGRO SIN CALBES | KTC |
|  | BJA-HELLA-NG | SOCKET BOMBILLO H4 BAQUELA TIPO HELLA PASTA NEGRO SIN CALBES | TAIWAN |

| | | | |
|---|--------------|---|--------|
|  | BJAHELLA | SOCKET BOMBILLO H4 TIPO HELLA SIN CABLE EN LOZA BLANCO | TAIWAN |
|  | 230-225-KTC | SOCKET BOMBILLO H7 PARA ALTA TEMPERATURA-CIERRE CON BLOQUEO CABLE 14AWG | KTC |
|  | 230-115 | SOCKET BOMBILLO H7 CHEVROLET DMAX - MAZDA 3 - MAZDA 6 | KTC |
|  | TAIWAN-18200 | SOCKET BOMBILLO H7 LOZA | TAIWAN |
|  | 230-071 | SOCKET BOMBILLO H7 CURVO ENCAUCHETADO | KTC |
|  | 230-100 | SOCKET BOMBILLO H7 CURVO LOZA | KTC |
| | DSA-30100 | | TAIWAN |

| | | | |
|--|--------------|---------------------------------------|--------|
|  | 230-229 | SOCKET BOMBILLO H8 | KTC |
|  | 230-230 | SOCKET BOMBILLO H9 | KTC |
|  | DSA-30110 | SOCKET BOMBILLO H10 | TAIWAN |
| | 230-110 | | KTC |
|  | 230-081 | SOCKET BOMBILLO H11 - 881-886-889-894 | KTC |
| | TAIWAN-30081 | | TAIWAN |
|  | DSA-30109 | SOCKET BOMBILLO H13 | TAIWAN |
| | 230-109 | | KTC |
|  | 230-074 | SOCKET BOMBILLO 880 | KTC |
|  | 230-005 | SOCKET BOMBILLO 9004-9007 LOZA | KTC |

| | | | |
|--|---------------|--|---------------|
|  | 230-006 | SOCKET BOMBILLO 9005 | KTC |
|  | 230-007 | SOCKET BOMBILLO 9006 | KTC |
|  | 230-069 | SOCKET BOMBILLO HYUNDAI | KTC |
|  | MG-10-01146 | SOCKET ELEVADOR 4-5P LOZA CON CABLE 16 Y RECUBRIMIENTO EN PLÁSTICO | GENUINE PARTS |
|  | 230-008 | SOCKET ELEVADOR 4-5P LOZA CON CABLE 16 Y RECUBRIMIENTO EN PLÁSTICO | KTC |
| | SQ-106-A | | TAIWAN |
|  | TAIWAN-230122 | SOCKET ELEVADOR 5P CABLE 14 NEGRO PLÁSTICO | TAIWAN |
|  | DSA-30063 | SOCKET ELEVADOR 5P TIPO PESADO | TAIWAN |

| | | | |
|---|--------------|---|--------|
|  | 230-063 | | KTC |
|  | TAIWAN-30073 | SOCKET ELEVADOR MINI 5P | TAIWAN |
| | 230-073 | | KTC |
|  | DSA-16011402 | SOCKET ELEVADOR MINI 5P | TAIWAN |
|  | 230-065 | SOCKET MODULO DAEWOO-BLAZER-PERA TEMPERATURA CORSA- ALTERNADOR SPARK | KTC |
|  | 230-086 | SOCKET MOTOVENTILADOR 2T NISSAN-BOBINA LAPIZ NISSAN SENTRA B13 | KTC |
|  | 230-234 | SOCKET MOTOVENTILADOR FORD FESTIVA-FIESTA- ECOSPORT | KTC |

| | | | |
|---|-------------|--|---------------|
|  | 230-034 | SOCKET PERAS - INYECTORES (AZUL) | KTC |
|  | 230-067 | SOCKET PERAS HYUNDAI - SENSOR OXIGENO ATOS | KTC |
|  | DSA-30130 | SOCKET PERA REVERSA 2T AVEO-CORSA-DAEWOO | TAIWAN |
|  | 230-004 | SOCKET PERA TEMPERATURA RENAULT TODOS LOGAN-MEGANE | KTC |
|  | AG-540C | SOCKET REGULADOR GR-540 CABLE 14 | TAIWAN |
|  | MG-10-01214 | SOCKET REGULADOR GR-540 CABLE 14 CON SOCKET | GENUINE PARTS |

| | | | |
|--|-----------|--|--------|
|  | 230-176 | SOCKET REGULADOR D101 (VR162) | KTC |
|   | DSA-30079 | SOCKET SENSORES VARIOS 2C- IAT TEMPERATURA AIRE CHEVROLET-HYUNDAI | TAIWAN |
| | DSA-30083 | SOCKET 2 VIAS GANCHO INYECTOR METALICO UNIVERSAL | TAIWAN |
|  | 230-085 | SOCKET SENSOR POSICIÓN CIGUENAL 2C CLIO-LOGAN- SYMBOL-MEGANE-KANGOO | KTC |
|  | DSA-3052 | SOCKET SWITCH ELEVIDRIOS UNIVERSAL 5P | TAIWAN |
| | 230-052 | | KTC |

| | | | |
|---|--------------|--|--------|
|  | 230-014 | SOCKET 4 VÍAS FLUJO AIRE HYUNDAI - DISTR | KTC |
|  | 230-148 | SOCKET VALVULA TEMPERATURA-SENSORES SUZUKI -VITARA-GM-STEEM 3P | KTC |
|  | 353-001 | SOPLADOR DE AIRE GRIS PARA LIMPIEZA DE CABINA 4.5mts 1PC | KTC |
|  | TAIWAN-16099 | SOPORTE MEDIDOR SOBREPONER 1P NEGRO PLÁSTICO 2" | TAIWAN |
|  | BT-58 | SOPORTE BATERÍA UNIVERSAL | TAIWAN |

| | | | |
|---|----------------------|--|---------------|
|  | <p>IRS-101E-8C</p> | <p>SWITCH BALANCÍN ON-OFF 3P REDONDO NEGRO 2.5 CM</p> | <p>TAIWAN</p> |
|  | <p>IRS-101-8C</p> | <p>SWITCH BALANCÍN ON-OFF 3 REDONDO ROJO 2.5 CM</p> | <p>TAIWAN</p> |
|  | <p>DSA-144508</p> | <p>SWITCH BALANCÍN ON-OFF-ON 3P 6V 20AMP REDONDO NEGRO</p> | <p>TAIWAN</p> |
|  | <p>DSA-ASW-20D-R</p> | <p>SWITCH BALANCÍN ON-OFF 3P OVALADA NEGRO PILOTO ROJO 3.1x1.95 CM</p> | <p>TAIWAN</p> |
|  | <p>SMRS-101</p> | <p>SWITCH BALANCÍN ON-OFF 2P RECTANGULAR NEGRO 1.5X1 CM</p> | <p>TAIWAN</p> |
|  | <p>SMRS-101-3E</p> | <p>SWITCH BALANCÍN ON-OFF 3P RECTANGULAR NEGRO MINI 1.5X1 CM</p> | <p>TAIWAN</p> |
|  | <p>251-001</p> | <p>SWITCH BALANCÍN ON-OFF 3C TECLA PILOTO ROJO 2X1 CM</p> | <p>KTC</p> |





| | | | |
|---|--------------|--|---------------|
|  | 251-101 | SWITCH BALANCÍN 1 GOLPE 2P TECLA NEGRO 2X1 CM CON CABLE | KTC |
|  | TAIWAN-51002 | SWITCH BALANCÍN 1 GOLPE 3P TECLA PILOTO ROJO 2X1 CM | TAIWAN |
|  | MRS-101 | SWITCH BALANCÍN ON-OFF 2P RECTANGULAR NEGRO PEQUEÑO 2X1 CM | TAIWAN |
|  | MG-04-01186 | SWITCH BALANCÍN ON-OFF 3P TECLA RECTANGULAR COLORES* | GENUINE PARTS |
|  | MRS-103 | SWITCH BALANCÍN MINI ON-OFF-ON 3P 1CM | TAIWAN |
|  | MG-04-01294 | SWITCH BALANCÍN MINI ON-OFF-ON 3P 1CM | GENUINE PARTS |

| | | | |
|---|-----------------|---|---------------|
|  | 251-003 | SWITCH BALANCÍN ON-OFF 3C NEGRO 3X1.5 CM | KTC |
|  | DSA-146106 | SWITCH BALANCÍN 2 BOTONES ROJOS ON-OFF 6P 12V 15A 250V AC-20A 125V AC | TAIWAN |
|  | 251-011 | SWITCH BALANCÍN ON-OFF 4C RECTANGULAR TECLA PILOTO ROJO 3X2.4 CM | KTC |
|  | MIRS-201 | SWITCH BALANCÍN ON-OFF 4P PEQUEÑO PILOTO ROJO 2X1.5 CM | TAIWAN |
|  | MG-04-01207R-4P | SWITCH BALANCÍN ON-OFF 4P PEQUEÑO PILOTO ROJO (212321-0121) | GENUINE PARTS |
|  | IRS-201-1C | SWITCH BALANCÍN ON-OFF 4P TECLA PILOTO ROJO 3X2.5 CM GRANDE | TAIWAN |
|  | GPM-006 | | GPM |

| | | | |
|--|--------------|---|---------------|
|  | ASW-17D | SWITCH BALANCÍN ON-OFF 1 GOLPE 4P LUCES TECLA PILOTO-SIMBOLO LUZ (APM-00000) *EXPLORADORAS* | TAIWAN |
| | MG-04-01205 | | GENUINE PARTS |
|  | 251-082 | SWITCH BALANCÍN TIPO PESADO ON-OFF 3P TECLA PILOTO ROJO LED 1.8X3.1 CM | KTC |
|  | TAIWAN-51013 | SWITCH BALANCÍN 1 GOLPE ON-OFF 2P NEGRO TECLA 4.3X2.5 CM | TAIWAN |
| | 251-013 | | KTC |
|  | 251-015 | SWITCH BALANCÍN TIPO PESADO ON-OFF 3P TECLA PILOTO ROJO 4.3X2.5 CM | KTC |
|  | MG-04-01123 | SWITCH BALANCÍN TIPO PESAD ON-OFF 4P TECLA PILOTO ROJO 4.3X2.5 24V | GENUINE PARTS |
|  | MG-04-01124 | SWITCH BALANCÍN TIPO PESADO <u>ON-OFF-ON</u> 3P TECLA PILOTO ROJO 24V 4.3X2.5 CM | GENUINE PARTS |

| | | | |
|---|--------------|--|--------|
|  | 251-016 | SWITCH BALANCÍN TIPO PESADO ON-OFF-ON 6P TECLA 4.3X2.5 CM *CON TORNILLO | KTC |
|  | TAIWAN-5169 | SWITCH BALANCÍN TIPO PESADO ON-OFF-ON 6P TECLA 4.3X2.5 CM *SIN TORNILLO | TAIWAN |
|  | DSA-1420102 | SWITCH BALANCÍN TIPO PESADO <u>ON-OFF-ON</u> 4P TECLA PILOTO ROJO-AMARILLO 12-24V 4.3X2.5 CM | TAIWAN |
|  | TAIWAN-51018 | SWITCH BALANCÍN TIPO PESADO <u>ON-OFF</u> 4P TECLA PILOTO ROJO-AMARILLO 4.3X2.5 12V | TAIWAN |
|  | 251-123 | SWITCH BALANCÍN 2 GOLPES 4P TECLA PILOTO ROJO-AMARILLO 4.3X2.5 24V GPM | KTC |
|  | GC-50515 | SWITCH ROSTER METÁLICO UNIVERSAL | TAIWAN |

| | | | |
|--|-------------|--|---------------|
|  | 231-002-E | SWITCH BOSTER METÁLICO UNIVERSAL | GPM |
|  | MG-04-01193 | SWITCH BOSTER METÁLICO UNIVERSAL | GENUINE PARTS |
|  | 251-053 | SWITCH CAMBIALUZ DE PIE DODGE UNIVERSAL *DS-5 (1972161 5U2Z11654A C0TF13480A C0TF13480B C0TF13A024A C0TZ13480A C0TZ13A024A C0TZ13A024A D2AB13480A2A D2AB13480AA D2AB13A024A2A) | KTC |
| | 251-053E | | GPM |
| | DS-5 | | TAIWAN |
| | MG-04-01155 | | GENUINE PARTS |
|  | DSA-KN3 | SWITCH CODILLO ON-OFF 3P | TAIWAN |
|  | KN-3B-103A | SWITCH CODILLO ON-OFF-ON 3P 10A 250VAC | TAIWAN |
|  | 251-028 | SWITCH CODILLO ON-OFF-ON 6P 20AMP 250VAC METÁLICO | KTC |
| | KN-3B-203A | SWITCH CODILLO ON-OFF-ON 6P 10AMP 250VAC METÁLICO | TAIWAN |

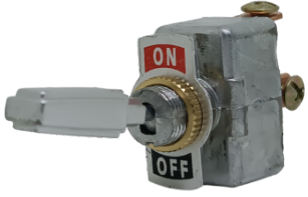
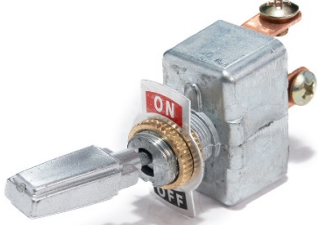
| | | | |
|---|----------------|---|---------------|
|  | 251-032 | SWITCH 1 GOLPE CODILLO 3P PLÁSTICO ROJO | KTC |
|  | MG-04-01171 | SWITCH CODILLO ON-OFF-ON 2P | GENUINE PARTS |
|  | MG-04-01169 | SWITCH CODILLO ON-OFF-ON 3P | GENUINE PARTS |
|  | DSA-1419204 | SWITCH CODILLO ON-OFF 2P 15AMP 250VAC METÁLICO 55X29X15MM (34577) | TAIWAN |
|  | TAIWAN-1061 | SWITCH CODILLO ON-OFF 2 GOLPES 2P PALANCA PLÁSTICA 50AMP | TAIWAN |
|  | MG-04-01182-2P | SWITCH CODILLO ON-OFF 2 GOLPES 2P PALANCA PLÁSTICA 50AMP | GENUINE PARTS |

| | | | |
|---|-------------|--|---------------|
|  | 251-061 | SWITCH CODILLO ON-OFF 2 GOLPES 2P METÁLICO 50AMP (34212) | KTC |
|  | TAIWAN-1062 | SWITCH CODILLO ON-OFF 2 GOLPES 3P METÁLICO 50AMP (34215) PALANCA | TAIWAN |
| | MG-04-01182 | SWITCH CODILLO ON-OFF 2 GOLPES 3P METÁLICO 50AMP (34215) PALANCA | GENUINE PARTS |
| | MG-04-01582 | SWITCH CODILLO 4P ON-OFF-ON | GENUINE PARTS |
|  | 251-062 | SWITCH CODILLO ON-OFF-ON 2 GOLPES 3P METÁLICO 50AMP (34215) PALANCA RETORNABLE | KTC |
| | ASW-07-D | SWITCH CODILLO 3P ON-OFF CON PILOTO 25AMP | TAIWAN |



| | | | |
|---------------|-------------|--|---------------|
| | RD-09029 | SWITCH CORTESÍA PUERTA DAEWOO RACER-CIELO (96235956) | TAIWAN |
| | GPM-036 | SWITCH CORTESÍA PUERTA UNIVERSAL PUNTILLA AJUSTABLE CON CAUCHO | GPM |
| TAIWAN-0036DS | TAIWAN | | |
| | TAIWAN-5199 | SWITCH CORTESÍA PUERTA MAZDA | TAIWAN |
| | MG-04-01212 | SWITCH CORTESÍA PUERTA UNIVERSAL PUNTILLA GRADUABLE | GENUINE PARTS |

| | | | |
|--|--------------------|---|--------------------------|
|  | <p>MG-04-01430</p> | <p>SWITCH CORTESÍA PUERTA RENAULT CLIO KANGOO MEGANE SCENIC DUSTER LOGAN SANDERO (7700427640)</p> | <p>GENUINE PARTS</p> |
| | <p>MG-04-01429</p> | <p>SWITCH CORTESÍA MALETERO RENAULT KANGOO-CLIO- LAGUNA (7700429418)</p> | <p>GENUINE PARTS</p> |
|  | <p>SQ-1200-S</p> | <p>SWITCH ELEVAVIDRIOS UNIVERSAL 5P FLECHA ILUMINADO</p> | <p>TAIWAN</p> |
|  | <p>DSA-012</p> | <p>SWITCH ELEVAVIDRIOS 5P FLECHA ILUMINADO CON PACHA</p> | <p>TAIWAN</p> |
|  | <p>MG-04-01048</p> | <p>SWITCH ELEVAVIDRIOS UNIVERSAL 5P FLECHA ILUMINADO + PACHA</p> | <p>GENUINE PARTS</p> |

| | | | |
|---|---------------|--|---------------|
|  | 251-039 | SWITCH ELEVAVIDRIOS UNIVERSAL 5P VENTANA AL CENTRO ILUMINADO *TOYOTA | KTC |
| MG-04-01051 | GENUINE PARTS | | |
|  | GPM-015 | SWITCH ELEVAVIDRIOS UNIVERSAL 5P VENTANA AL CENTRO + PACHA SIN CABLE | GPM |
|  | MG-04-01049 | SWITCH ELEVAVIDRIOS UNIVERSAL 5P VENTANA ARRIBA* CON PACHA BLANCA | GENUINE PARTS |
|  | MG-04-01050 | SWITCH ELEVAVIDRIOS UNIVERSAL 5P VENTANA ARRIBA | GENUINE PARTS |

| | | | |
|---|--------------|--|---------------|
|  | 251-120 | SWITCH ELEVAVIDRIOS 5P FLECHA CON RAMAL DE LADO (CABLES Y SOCKET) | KTC |
| | 014018102-DS | SWITCH ELEVAVIDRIOS 5P FLECHA CON RAMAL RETIRABLE (CABLES Y SOCKET) | TAIWAN |
|  | MG-04-01053 | SWITCH ELEVAVIDRIOS 5P FLECHA CON RAMAL (CABLES Y SOCKET) | GENUINE PARTS |
|  | MG-04-01054 | SWITCH ELEVAVIDRIOS 5P VENTANA CON RAMAL (CABLES Y SOCKET) | GENUINE PARTS |
|  | 014018101-DS | SWITCH ELEVAVIDRIOS 5P VENTANA CON RAMAL QUE SE RETIRA (CABLES Y SOCKET) | TAIWAN |

| | | | |
|--|-----------|--|--------|
|  | 251-043 | SWITCH ELEVAVIDRIOS 6P TIPO SPAL VENTANA ILUMINADO | KTC |
|  | 66390 | SWITCH ELEVAVIDRIOS 6P TIPO SPAL VENTANA - FLECHA ILUMINADO | TAIWAN |
|  | 251-046 | SWITCH ELEVAVIDRIOS 6P TIPO SPAL MITSUBISHI ILUMINADO | KTC |
|  | DSA-51090 | SWITCH ELEVAVIDRIOS 6P TIPO SPAL FLECHA ILUMINADO (NUEVOS MODELOS) | TAIWAN |
| | 251-090 | | KTC |
|  | 251-092 | SWITCH ELEVAVIDRIOS 6P TIPO SPAL VENTANA ILUMINADO | KTC |

| | | | |
|---|-------------|---|---------------|
| #¡VALOR! | MG-04-01011 | SWITCH ELEVAVIDRIOS 5P RENAULT 9 | GENUINE PARTS |
|  | MG-04-01015 | SWITCH ELEVAVIDRIOS 5P RENAULT DUSTER-LOGAN-CLIO I-MEGANE I-SCENIC I-KANGOO (8200467793 7700838101 7700429998 7700429999) | GENUINE PARTS |
|  | 251-103 | SWITCH ELEVAVIDRIOS 6P RENAULT DUSTER-LOGAN-KANGOO-CLIO-MEGAN-SCENIC (7700429998) | KTC |
| | MG-04-01014 | | GENUINE PARTS |
|  | MG-04-01013 | SWITCH ELEVAVIDRIOS 5P RENAULT CLIO II (7700307605 7700436534 8200197251 8200090316) | GENUINE PARTS |
|  | 251-104 | SWITCH ELEVAVIDRIOS 6P RENAULT CLIO-KANGOO | KTC |

| | | | |
|---|--------------------|--|----------------------|
|  | <p>DSA-51104</p> | <p>(7700838101)</p> | <p>TAIWAN</p> |
|  | <p>MG-04-01859</p> | <p>SWITCH ELEVAVIDRIOS 6P RENAULT CLIO-HYUNDAI-KANGOO (7700838101) (662483)</p> | <p>GENUINE PARTS</p> |
|  | <p>MG-04-01854</p> | <p>SWITCH ELEVAVIDRIOS DOBLE 7P RENAULT CLIO IV-CAPTUR (254113300R)</p> | <p>GENUINE PARTS</p> |
|  | <p>MG-04-01920</p> | <p>SWITCH ELEVAVIDRIOS DOBLE 7P RENAULT CLIO IV (809611667R, 254118044R, 254117873R)</p> | <p>GENUINE PARTS</p> |
|  | <p>MG-04-01856</p> | <p>SWITCH ELEVAVIDRIOS DOBLE 7P RENAULT CLIO IV-CAPTUR -TRAFFIC - KANGOO (254118722R)</p> | <p>GENUINE PARTS</p> |

| | | | |
|---|--------------------|--|----------------------|
|  | <p>MG-04-01789</p> | <p>SWITCH ELEVAVIDRIOS DOBLE 6P RENAULT DUSTER 2009 - 2016-LOGAN-SANDERO-OROCH DELANTERO DOBLE IZQUIERDO (8200107772)</p> | <p>GENUINE PARTS</p> |
|  | <p>MG-04-01857</p> | <p>SWITCH ELEVAVIDRIOS 6P RENAULT RENAULT LOGAN 1.0 2016- LOGAN 1.6 2015-2021 -DUSTER 1.3 2022- DUSTER 1.6 2015- DUSTER 2.0 2016-2020- FLUENCE 2.0 2015-2018- OROCH 1.3 2022- OROCH 1.6 2015- OROCH 2.0 2015-2022- SANDERO 1.0 2015- SANDERO 1.6 2015- SANDERO 2.0 2015-2022 *SENCILLO (7899751958806)</p> | <p>GENUINE PARTS</p> |
|  | <p>TAIWAN-1065</p> | <p>SWITCH ELEVAVIDRIOS DOBLE 7C RENAULT LOGAN -N SANDERO 2017 / 44R PACHA BLANCA</p> | <p>TAIWAN</p> |
|  | <p>MG-04-01855</p> | <p>SWITCH ELEVAVIDRIOS DOBLE 6P RENAULT LOGAN 2 II - SANDERO 12-20 (254214937R)</p> | <p>GENUINE PARTS</p> |

| | | | |
|---|--------------------|--|----------------------|
|  | <p>TAIWAN-1064</p> | <p>SWITCH ELEVAVIDRIOS DOBLE 10P RENAULT SANDERO - DUSTER *PACHA AZUL</p> | <p>TAIWAN</p> |
|  | <p>MG-04-01864</p> | <p>SWITCH ELEVAVIDRIOS DOBLE 10P RENAULT MEGANE II 2003-2014 - LAGUNA II, 2001-2014 - TRAFIC II 2001-2014 (8200315034)</p> | <p>GENUINE PARTS</p> |
|  | <p>MG-04-01016</p> | <p>SWITCH ELEVAVIDRIOS DOBLE 10P RENAULT CLIO-MEGANE 2 03/08-LAGUNA-SCENIC-TRAFIC *IZQUIERDO PACHA NEGRA (8200060045)</p> | <p>GENUINE PARTS</p> |
|  | <p>MG-04-01869</p> | <p>SWITCH ELEVAVIDRIOS 10P RENAULT CLIO III MODUS-TWINGO II 2005-2009-2019- DUSTER TRASERO (8200214943, 8200 214 943)</p> | <p>GENUINE PARTS</p> |

| | | | |
|--|--------------------|---|----------------------|
|  | <p>MG-04-01790</p> | <p>SWITCH ELEVAVIDRIOS 10P RENAULT CLIO III MODUS-TWINGO II 2005-2009-2019- DUSTER TRASERO (8200214943, 8200 214 943)</p> | <p>GENUINE PARTS</p> |
|  | <p>MG-04-01864</p> | <p>SWITCH ELEVAVIDRIOS 10P RENAULT MEGANE II 2003-2014 - LAGUNA II, 2001-2014 - TRAFIC II 2001-2014 (8200315034)</p> | <p>GENUINE PARTS</p> |
|  | <p>MG-04-01413</p> | <p>SWITCH ELEVAVIDRIOS 6P FORD FIESTA (7S6514529BA - 7S6514529BA 4L5514529AA)</p> | <p>GENUINE PARTS</p> |
|  | <p>MG-04-01812</p> | <p>SWITCH ELEVAVIDRIOS 10P PPAL VOLKSWAGEN JETTA 2.5 (08-12)- AMAROK - PASSAT - TIGUAN (10-18)</p> | <p>GENUINE PARTS</p> |

| | | | |
|--|---------------------|---|----------------------|
|  | <p>MG-04-01387</p> | <p>SWITCH ELEVAVIDRIOS UNIVERSAL 6P TIPO PESADO</p> | <p>GENUINE PARTS</p> |
|  | <p>251-019</p> | <p>SWITCH ELEVAVIDRIOS 6C TIPO PESADO TECLA NEGRA 4.3X2.5</p> | <p>KTC</p> |
| | <p>TAIWAN-51019</p> | | <p>TAIWAN</p> |
|  | <p>231-014</p> | <p>SWITCH IGNICIÓN CHEVROLET DMAX-RODEO-DENVER (8-97349940)</p> | <p>GPM</p> |
|  | <p>MG-02-13021</p> | <p>SWITCH IGNICIÓN CHEVROLET NPR-NKR</p> | <p>GENUINE PARTS</p> |

| | | | |
|---|-------------|---|---------------|
|  | MG-02-13028 | SWITCH IGNICIÓN CHEVROLET DMAX *4+4 PINES | GENUINE PARTS |
|  | MG-02-02009 | SWITCH IGNICIÓN RENAULT 4-6-12 (770053335) | GENUINE PARTS |
|  | MG-02-02012 | SWITCH IGNICIÓN RENAULT 9 GAMMA | GENUINE PARTS |
|  | MG-02-02068 | SWITCH IGNICIÓN RENAULT LOGAN-SANDERO | GENUINE PARTS |
|  | DSA-017 | SWITCH IGNICIÓN RENAULT LOGAN - SANDERO-CLIO (7701471220) | TAIWAN |
| | GPM-017 | | GPM |

| | | | |
|---|--------------------|--|----------------------|
|  | <p>MG-02-02003</p> | <p>SWITCH IGNICIÓN RENAULT KANGOO (WA80301 - 8200176685)</p> | <p>GENUINE PARTS</p> |
|  | <p>231-025</p> | <p>SWITCH IGNICIÓN RENAULT KANGOO (8200176685)</p> | <p>KTC</p> |
|  | <p>MG-02-12023</p> | <p>SWITCH IGNICIÓN MAZDA B1600-2000-2200 5P</p> | <p>GENUINE PARTS</p> |
|  | <p>MG-02-12025</p> | <p>SWITCH IGNICIÓN MAZDA B1600-2000-2200-2400 *SIN CABLE</p> | <p>GENUINE PARTS</p> |

| | | | |
|--|--------------------|---|----------------------|
|  | <p>MG-02-12018</p> | <p>SWITCH IGNICIÓN MAZDA 323 MODELO 86</p> | <p>GENUINE PARTS</p> |
|  | <p>MG-02-09030</p> | <p>SWITCH IGNICIÓN HYUNDAI TOYOTA LAND CRUISER (6906460021)</p> | <p>GENUINE PARTS</p> |
|  | <p>MG-02-07016</p> | <p>SWITCH IGNICIÓN HYUNDAI ATOS (8190022A43)</p> | <p>GENUINE PARTS</p> |
|  | <p>MG-02-07042</p> | <p>SWITCH IGNICIÓN HYUNDAI ACCENT - VERNA (8190022A43)</p> | <p>GENUINE PARTS</p> |

| | | | |
|---|--------------------|---|--------------------------|
|  | <p>MG-02-07073</p> | <p>SWITCH IGNICIÓN HYUNDAI TUCSON 05-08 *4 PINES (819202EA30)</p> | <p>GENUINE PARTS</p> |
|  | <p>MG-02-07008</p> | <p>SWITCH IGNICIÓN DAEWOO RACER-CIELO</p> | <p>GENUINE PARTS</p> |
|  | <p>MG-02-07015</p> | <p>SWITCH IGNICIÓN DAEWOO (93740298)</p> | <p>GENUINE PARTS</p> |
|  | <p>MG-02-07047</p> | <p>SWITCH IGNICIÓN KIA PICANTO CON LLAVE 06-09 (81905-07000)</p> | <p>GENUINE PARTS</p> |

| | | | |
|---|--------------------|--|----------------------|
|  | <p>MG-02-07070</p> | <p>SWITCH IGNICIÓN KIA PICANTO CON LLAVE *6+4 PINES (819001GM00)</p> | <p>GENUINE PARTS</p> |
|  | <p>MG-02-07081</p> | <p>SWITCH IGNICIÓN KIA SPORTAGE 06-10 *2 PINES (819001FB00)</p> | <p>GENUINE PARTS</p> |
|  | <p>MG-02-10013</p> | <p>SWITCH IGNICIÓN NISSAN SENTRA B14 1995-1998 (487002m300)</p> | <p>GENUINE PARTS</p> |
|  | <p>231-006</p> | <p>SWITCH IGNICIÓN 11P EAGLE IHC TRUCKS-INTERNATIONAL (31114)</p> | <p>KTC</p> |
|  | <p>231-011</p> | <p>SWITCH IGNICIÓN UNIVERSAL PARA MAQUINARIA 3 PINES- 3 POSICIONES (ST30 - 514000)</p> | <p>KTC</p> |

| | | | |
|---|--------------|---|--------|
|  | 231-012 | SWITCH IGNICIÓN UNIVERSAL TIPO PESADO (CHEVROLET-TOYOTA-MITSUBISHI-HINO) | KTC |
|  | 231-108007 | SWITCH IGNICIÓN UNIVERSAL | KTC |
|  | 231-108009 | SWITCH IGNICIÓN UNIVERSAL TIPO PESADO (CHEVROLET-TOYOTA-MITSUBISHI-HINO) | KTC |
| | 231108009-DS | | TAIWAN |
| | 231-013 | SWITCH IGNICIÓN UNIVERSAL TIPO TORICA | GPM |
| | ISC-4 | | TAIWAN |

| | | | |
|---|--------------------|---|----------------------|
|  | <p>DSA-100501</p> | <p>SWITCH IGNICIÓN TRACTOR 6P</p> | <p>TAIWAN</p> |
|  | <p>GPM-003</p> | <p>SWITCH LUCES HALAR 1 GOLPE 2C HALAR TIPO 21000 *NEGRO</p> | <p>GPM</p> |
|  | <p>251-023</p> | <p>SWITCH LUCES HALAR 1 GOLPE 2C HALAR TIPO 21000 *NEGRO</p> | <p>KTC</p> |
| | <p>SW-12019-P</p> | | <p>TAIWAN</p> |
|  | <p>251-105-E</p> | <p>SWITCH LUCES HALAR 1 GOLPE 2C OFF-ON HALAR TIPO 21000 12V-10AMP CUELLO LARGO (13MM) *NEGRO</p> | <p>KTC</p> |
|  | <p>MG-04-01164</p> | <p>SWITCH LUCES HALAR 1 GOLPE 2C OFF-ON HALAR TIPO 21000 12V 16AMP CUELLO LARGO (13MM) *NEGRO</p> | <p>GENUINE PARTS</p> |

| | | | |
|--|--------------|---|---------------|
| | MG-04-01165 | SWITCH LUCES HALAR 1 GOLPE 2C OFF-ON HALAR TIPO 21000 12V 20AMP CUELLO LARGO (8MM) *NEGRO | GENUINE PARTS |
|  | DSA-14006304 | SWITCH LUCES HALAR 1 GOLPE 2C OFF-ON HALAR TIPO 21000 12V 16AMP CUELLO LARGO (8MM) *ROJO | TAIWAN |
|  | DSA-6307 | SWITCH LUCES HALAR 1 GOLPE ON-OFF 12V 16AMP 8MM UNIVERSAL CUERPO PEQUEÑO-BOTON GRANDE *ROJO | TAIWAN |
|  | 251-024 | SWITCH LUCES HALAR 1 GOLPE 2C 75AMP *PLATEADO | KTC |
| | TAIWAN-HD75 | | TAIWAN |
| | MG-04-01179 | | GENUINE PARTS |
| | HT-11 | SWITCH LUCES HALAR 1 GOLPE MANITO | TAIWAN |

| | | | |
|---|-------------|---|---------------|
| | MG-04-01197 | SWITCH LUCES HALAR 1 GOLPE | GENUINE PARTS |
| | MG-08-01026 | SWITCH LUCES HALAR 2 GOLPES 5C | GENUINE PARTS |
|  | 251-027 | SWITCH LUCES HALAR 2 GOLPES 4C | KTC |
| | HT-12 | | TAIWAN |
|  | MG-08-01025 | SWITCH LUCES HALAR 4C 2 GOLPES CON FUSIBLE HS-89 LS-202 | GENUINE PARTS |
|  | MG-04-01098 | SWITCH LUCES PERILLA CHEVROLET CORSA-CHEVY-ASTRA-VECTRA-TIGRA CON CONTROL DE INTENSIDAD | GENUINE PARTS |

| | | | |
|---|-------------|---|---------------|
|  | GPM-031 | SWITCH ELECTRICO CON CONTROL DE INTENSIDAD DE LUZ TABLERO (90213283) | GPM |
|  | 261-002 | SWITCH LIMPIABRISAS CHEVROLET AVEO-SAIL-MATIZ 3 * 11 PINES (96602570) | GPM |
|  | MG-01-07232 | SWITCH PALANCA DIRECCIONAL 9+2 PINES CHEVROLET AVEO (96602570) | GENUINE PARTS |
|  | GPM-018 | SWITCH PALANCA DIRECCIONAL CHEVROLET AVEO 04-08-SAIL-SPARK-CRONOS MANDO *7 PINES (96540684) | GPM |
| | MG-01-07096 | | GENUINE PARTS |
|  | GPM-026 | SWITCH PALANCA DIRECCIONAL CHEVROLET AVEO 07-11-SPARK-CRONOS * 7+3 PINES (96540683) | GPM |
| | MG-01-07012 | | GENUINE PARTS |
|  | GPM-029 | SWITCH DIRECCIONAL CHEVROLET SPARK-MATIZ 3 CABLES * 7 PINES (96314332) | GPM |

| | | | |
|---|--------------------|---|----------------------|
|  | <p>MG-01-07040</p> | <p>SWITCH PALANCA LUZ/DIRECCIONAL CHEVROLET ATOS</p> | <p>GENUINE PARTS</p> |
|  | <p>MG-01-07016</p> | <p>SWITCH LUCES/DIRECCIONAL CORSA PALANCA</p> | <p>GENUINE PARTS</p> |
|  | <p>GPM-009</p> | <p>SWITCH LUZ/DIRECCIONAL CHEVROLET D-MAX 3.0-3.5 MODELOS NUEVOS (8-97360691-0)</p> | <p>GPM</p> |
|  | <p>MG-01-12002</p> | <p>SWITCH PALANCA DIRECCIONAL CHEVROLET-LUV 2300 (8-94434434-0 - 8-97068775-0)</p> | <p>GENUINE PARTS</p> |

| | | | |
|---|--------------------|---|----------------------|
|  | <p>MG-01-12017</p> | <p>SWITCH PALANCA DIRECCIONAL/LUCES CHEVROLET DMAX (8-97360691-0)</p> | <p>GENUINE PARTS</p> |
|  | <p>GPM-024</p> | <p>SWITCH PALANCA DIRECCIONAL MAZDA BT-50 - 2500-2600 * 14 PINES (UJ06-66-122)</p> | <p>GPM</p> |
| | <p>MG-01-11012</p> | | <p>GENUINE PARTS</p> |
|  | <p>MG-01-11014</p> | <p>SWITCH DIRECCIONAL 15 PINES MAZDA BT-50 *15 PINES (UR7966122)</p> | <p>GENUINE PARTS</p> |
|  | <p>MG-01-11002</p> | <p>SWITCH PALANCA LUZ/DIRECCIONAL MAZDA 323 MODELO 1986-1989 (G113-66-120B RHD)</p> | <p>GENUINE PARTS</p> |
|  | <p>MG-01-02006</p> | <p>SWITCH PALANCA DIRECCIONAL RENAULT 4-6-12 *5 PINES (510031612501 - 7701348654)</p> | <p>GENUINE PARTS</p> |

| | | | |
|--|-------------|--|---------------|
|  | MG-01-02043 | SWITCH PALANCA LIMPIABRISAS RENAULT 9 *7 PINES (7702127477, 7701349418) | GENUINE PARTS |
|  | DSA-011 | SWITCH PALANCA LUZ/DIRECCIONAL RENAULT 9 GAMMA 6+4 PINES | TAIWAN |
| | GPM-011 | | GPM |
| | MG-01-02003 | | GENUINE PARTS |
|  | MG-01-01031 | SWITCH PALANCA LUZ/DIRECCIONAL PEUGEUT-CITROEN | GENUINE PARTS |
|  | MG-01-01034 | SWITCH PALANCA LUZ PEUGEUT-CITROEN | GENUINE PARTS |
|  | GPM-033 | SWITCH PALANCA DIRECCIONAL RENAULT TWINGO NEGRO (7700822445) | GPM |
| | MG-01-02012 | | GENUINE PARTS |

| | | | |
|---|---------------------|---|----------------------|
|  | <p>MG-01-02012G</p> | <p>SWITCH PALANCA DIRECCIONAL RENAULT TWINGO GRIS (7700822445)</p> | <p>GENUINE PARTS</p> |
|  | <p>MG-01-02063</p> | <p>SWITCH PALANCA LIMPIABRISAS RENAULT TWINGO *12 PINES (7701046628)</p> | <p>GENUINE PARTS</p> |
|  | <p>MG-01-02025</p> | <p>SWITCH PALANCA LUZ/DIRECCIONAL RENAULT LOGAN *13 PINES (7700432340)</p> | <p>GENUINE PARTS</p> |
|  | <p>MG-01-02054</p> | <p>SWITCH PALANCA LUZ/DIRECCIONAL RENAULT SANDERO II - LOGAN II - CAPTUR- CLIO IV - TRAFIC III 15+2 PINES (93160239 - 4410524 - 7701048912)</p> | <p>GENUINE PARTS</p> |
|  | <p>MG-01-02028</p> | <p>SWITCH PALANCA LUZ/DIRECCIONAL RENAULT CLIO I (7701053874 7701067948 Valeo: 251570 ERA: 440318)</p> | <p>GENUINE PARTS</p> |

| | | | |
|--|-------------|--|---------------|
|  | GPM-019 | SWITCH PALANCA DIRECCIONAL RENAULT DUSTER-LOGAN-SANDERO 12 * 15 PINES (255400337R 8201167988 251682) | GPM |
|  | MG-01-02044 | | GENUINE PARTS |
|  | MG-01-02029 | SWITCH PALANCA LUZ/DIRECCIONAL RENAULT MEGANE *13+2 PINES (7701047255) | GENUINE PARTS |
|  | MG-01-02010 | SWITCH PALANCA DIRECCIONAL RENAULT MEGANE - SCENIC 13 PINES (7701040734) | GENUINE PARTS |
|  | MG-01-02034 | SWITCH PALANCA DIRECCIONAL/LIMPIABRISAS RENAULT MEGANE 13 PINES (7701047258 /Valeo: 251926) | GENUINE PARTS |
|  | MG-01-02053 | SWITCH PALANCA LUZ/DIRECCIONAL RENAULT LOGAN II-SANDERO II - CAPTUR - CLIO IV - TWINGO III 15+2 PINES (255403601R 8201167978 251686) | GENUINE PARTS |
|  | MG-01-02055 | SWITCH PALANCA LUZ/DIRECCIONAL RENAULT LOGAN - LOGAN MVC - SANDERO - STEPWAY 13+2 PINES (6001551365 251606) | GENUINE PARTS |

| | | | |
|--|---------------|--|---------------|
| | MG-01-02058 | SWITCH PALANCA LUZ/DIRECCIONAL RENAULT LOGAN II-SANDERO II 15+2 PINES (255401642R 8201137975 251685) | GENUINE PARTS |
|  | MG-01-07009-1 | SWITCH PALANCA LIMPIABRISAS DAEWOO LANOS (96230798 / 399331-1000) | GENUINE PARTS |
| #¡VALOR! | MG-02-07010 | SWITCH PALANCA LUZ/DIRECCIONAL DAEWOO LACETTI (96387324 - 509321-1000) | GENUINE PARTS |
|  | MG-01-07002 | SWITCH PALANCA DIRECCIONAL DAEWOO CIELO 10 PINES (96192078-96215551) | GENUINE PARTS |
|  | MG-01-07013 | SWITCH PALANCA LIMPIABRISAS DAEWOO KALOS 9 PINES (96540686 / 520330-1000) | GENUINE PARTS |

| | | | |
|--|--------------------|---|--------------------------|
|  | <p>MG-01-07041</p> | <p>SWITCH PALANCA LUZ/DIRECCIONAL HYUNDAI ATOS (9240002102K)</p> | <p>GENUINE PARTS</p> |
|  | <p>GPM-035</p> | <p>SWITCH PALANCA LUZ/DIRECCIONAL SUZUKI SJ410- SUPER CARRY (37400-83410)</p> | <p>GPM</p> |
|  | <p>MG-01-14002</p> | <p>SWITCH PALANCA LUCES/DIRECCIONAL SUZUKI SJ410 EX</p> | <p>GENUINE PARTS</p> |
|  | <p>MG-01-08010</p> | <p>SWITCH PALANCA DIRECCIONAL TOYOTA HILUX YH50 YH52 YH55 YH57 YH6 #RN50 (84310-35180 LHD)</p> | <p>GENUINE PARTS</p> |
|  | <p>MG-01-12001</p> | <p>SWITCH PALANCA DIRECCIONAL ISUZU - TFR TURBO KB22 KB23 KB280D KB46 (8-94381454-2 / 8-97068773-0 RHD)</p> | <p>GENUINE PARTS</p> |

| | | | |
|---|-----------------------|--|----------------------|
|  | <p>MG-04-01328</p> | <p>SWITCH LUCES TABLERO KODIAK</p> | <p>GENUINE PARTS</p> |
| | <p>252-102035</p> | <p>SWITCH DIRECCIONAL UNIVERSAL TIPO PESADO NEGRO CON SOCKET</p> | <p>KTC</p> |
|  | <p>MG-01-07032</p> | <p>SWITCH PALANCA LUZ/DIRECCIONAL UNIVERSAL METÁLICO *HL-1000*</p> | <p>GENUINE PARTS</p> |
|  | <p>DSA-SFA-1-1003</p> | <p>SWITCH PARQUEO EMERGENCIA CON CABLE</p> | <p>TAIWAN</p> |
|  | <p>MG-04-01058</p> | <p>SWITCH PARQUEO UNIVERSAL</p> | <p>GENUINE PARTS</p> |

| | | | |
|--|--------------------|--|----------------------|
|  | <p>MG-04-01060</p> | <p>SWITCH PARQUEO RENAULT 9</p> | <p>GENUINE PARTS</p> |
| | <p>MG-04-01062</p> | <p>SWITCH PARQUEO RENAULT CLIO II 4 CONEXION</p> | <p>GENUINE PARTS</p> |
|  | <p>MG-04-01063</p> | <p>SWITCH PARQUEO RENAULT CLIO II 8 CONEXION</p> | <p>GENUINE PARTS</p> |
|  | <p>MG-04-01309</p> | <p>SWITCH PARQUEO RENAULT SCENIC-MEGANE I</p> | <p>GENUINE PARTS</p> |
|  | <p>MG-04-01355</p> | <p>SWITCH PARQUEO RENAULT SANDERO-LOGAN-DUSTER 8 PINES</p> | <p>GENUINE PARTS</p> |





| | | | |
|---|--------------------|--|----------------------|
|  | <p>MG-04-01943</p> | <p>SWITCH PARQUEO RENAULT DUSTER - CAPTUR - CLIO IV - ZOE *5 PINES (252907372R)</p> | <p>GENUINE PARTS</p> |
|  | <p>MG-04-01840</p> | <p>SWITCH PARQUEO RENAULT SANDERO-LOGAN-DUSTER 16-ON 6 PINES (252908988R)</p> | <p>GENUINE PARTS</p> |
|  | <p>MG-04-01435</p> | <p>SWITCH PARQUEO RENAULT LOGAN - SANDERO *8 PINES (6001546813)</p> | <p>GENUINE PARTS</p> |
|  | <p>MG-04-01942</p> | <p>SWITCH PARQUEO Y BLOQUEO PUERTAS RENAULT TWINGO II - MASTER III *6 PINES (252100991R)</p> | <p>GENUINE PARTS</p> |
|  | <p>MG-04-01412</p> | <p>SWITCH PARQUEO RENAULT ESPACE - LAGUNA - MASTER *4 PINES (8200442724 - 662451)</p> | <p>GENUINE PARTS</p> |

| | | | |
|---|--------------------|---|--------------------------|
|  | <p>MG-04-01064</p> | <p>SWITCH PARQUEO RENAULT KANGOO 8 PINES (7700308821, 252900266R, 8200090307, 320050701R, 8200523539)</p> | <p>GENUINE PARTS</p> |
|  | <p>MG-04-01332</p> | <p>SWITCH PARQUEO HYUNDAI</p> | <p>GENUINE PARTS</p> |
|  | <p>MG-04-01376</p> | <p>SWITCH PARQUEO DAEWOO 8 PINES (96231858)</p> | <p>GENUINE PARTS</p> |
|  | <p>MG-04-01377</p> | <p>SWITCH PARQUEO HYUNDAI ACCENT 1.3 GASOLINA (93790-22000)</p> | <p>GENUINE PARTS</p> |
|  | <p>MG-04-01322</p> | <p>SWITCH PARQUEO CHEVROLET DMAX GRIS</p> | <p>GENUINE PARTS</p> |

| | | | |
|---|--------------------|---|----------------------|
|  | <p>MG-04-01072</p> | <p>SWITCH PARQUEO CHEVROLET CORSA-CHEVY-TIGO</p> | <p>GENUINE PARTS</p> |
|  | <p>231-022</p> | <p>SWITCH PARQUEO HYUNDAI ACCENT 99-07-GYRO (9379025000)</p> | <p>KTC</p> |
|  | <p>231-024</p> | <p>SWITCH PARQUEO RENAULT LOGAN-DUSTER-SANDERO (8200602232)</p> | <p>KTC</p> |
|  | <p>MG-04-01319</p> | <p>SWITCH PARQUEO CHEVROLET D-MAX ROJO</p> | <p>GENUINE PARTS</p> |
|  | <p>DSA-010</p> | <p>SWITCH PARQUEO NHR-NKR-NPR GRIS (8972024780)</p> | <p>TAIWAN</p> |

| | | | |
|---|--------------|--|---------------|
|  | MG-04-01077 | 8970763442) | GENUINE PARTS |
|  | MG-04-01077A | SWITCH PARQUEO NHR-NKR-NPR NEGRO (8972024780 8970763442) | GENUINE PARTS |
| | GPM-025 | | GPM |
|  | MG-04-01082 | SWITCH BLOQUEO PUERTAS RENAULT CLIO 5 PINES | GENUINE PARTS |
| | MG-04-01192 | SWITCH PRECALENTAMIENTO 12V 60AMP UNIVERSAL | GENUINE PARTS |
|  | 251-036 | SWITCH PRECALENTAMIENTO 12V 60A (24360) | KTC |
| | 251-036-E | SWITCH PRECALENTAMIENTO 12V 60A (24360) | GPM |

| | | | |
|---|-------------|--|---------------|
| | 251-087 | SWITCH PRECALENTAMIENTO BOTON ROJO (24360) | KTC |
|  | 251-086 | SWITCH PRECALENTAMIENTO PILOTO LED ROJO 50A 12V (220) - HEAVY DUTY | KTC |
|  | PBS-12A | SWITCH PULSADOR ON-OFF CUADRADO 2P BOTON ROJO | TAIWAN |
| | PBS-14A | SWITCH PULSADOR ON-OFF HEXAGONAL 2P BOTON ROJO | TAIWAN |
|  | PBS-11A | SWITCH PULSADOR ON-OFF REDONDO 2P BOTON ROJO | TAIWAN |
| | DSA-144504 | SWITCH START/PITO REDONDO 2P BOTON ROJO 250V 1.5AMP 2.7x133CM | TAIWAN |
|  | PBS-11B | SWITCH START/PITO REDONDO 2P ROJO | TAIWAN |
| | MG-04-01295 | | GENUINE PARTS |
|  | PBS-12B | SWITCH START/PITO CUADRADO 2P ROJO | TAIWAN |

| | | | |
|---|-----------|--|--------|
| | PBS-14B | SWITCH START/PITO HEXAGONAL 2P BOTON ROJO | TAIWAN |
|  | 251-100 | SWITCH START/PITO + CABLE 2P | KTC |
| | PBS-26B | SWITCH START/PITO REDONDO 2P CROMADO BOTÓN ROJO | TAIWAN |
|  | PBS-28B | SWITCH START/PITO 2P METÁLICO CONVEXO | TAIWAN |
|  | PBS-28B-2 | SWITCH START/PITO HEXAGONAL 2P METÁLICO PLANO | TAIWAN |
|  | DSA-50525 | SWITCH START/PITO REDONDO PLATEADO 2P TIPO MERIT | TAIWAN |
|  | GC-50454 | SWITCH START/PITO REDONDO NEGRO ABRAZADER PLATEADA 2P TIPO MERIT | TAIWAN |
| | GPM-022 | | GPM |
| | 251-037 | | KTC |

| | | | |
|---|--------------------|--|----------------------|
|  | <p>MG-04-01180</p> | <p>SWITCH START/PITO REDONDO NEGRO TODO 2P TIPO MERIT *MG-04-01180BL</p> | <p>GENUINE PARTS</p> |
|  | <p>251-102</p> | <p>SWITCH STARTER REDONDO NEGRO BOTON PLANO PEQUEÑO</p> | <p>KTC</p> |
|  | <p>MG-04-01134</p> | <p>SWITCH STARTER REDONDO NEGRO *START PEQUEÑO (0005456314)</p> | <p>GENUINE PARTS</p> |
|  | <p>L-811</p> | <p>SWITCH START/PITO CON ABRAZADERA</p> | <p>TAIWAN</p> |
|  | <p>DSA-145302</p> | <p>SWITCH BOTÓN FRENO EMERGENCIA OFF 6.8X6.8X4.9CM</p> | <p>TAIWAN</p> |
|  | <p>MG05-01073</p> | <p>TAPA FRASCO AGUA CHEVROLET SPARK-7.24-CHRONOS-OPTRA</p> | <p>GENUINE PARTS</p> |

| | | | |
|---|---------------------|---|----------------------|
|  | <p>DSA-14019704</p> | <p>TAPA FRASCO AGUA CHEVROLET SPARK-7.24-CHRONOS-OPTRA (96420303-96293957-96351578-96312510-90500006)</p> | <p>TAIWAN</p> |
|  | <p>MG05-01073</p> | <p>TAPA FRASCO DE AGUA ORIGINAL SPARK - AVEO (94539597)</p> | <p>GENUINE PARTS</p> |
|  | <p>DSA-14005025</p> | <p>TAPA FRASCO AGUA CHEVROLET AVEO OPTRA CORSA 1.6 07-11 (90108850-90264493-90409256)</p> | <p>TAIWAN</p> |
|  | <p>MG-05-01255</p> | <p>TAPA FRASCO AGUA RENAULT CLIO-LAGUNA-MEGANE-TWINGO-LOGAN (7700805131)</p> | <p>GENUINE PARTS</p> |
| | <p>DSA-14005008</p> | | <p>TAIWAN</p> |
|  | <p>DSA-56000504</p> | <p>TAPA TANQUE REFRIGERANTE RADIADOR NEGRO RENAULT ALPINE-NISSAN-SUZUKI (7700805031)</p> | <p>TAIWAN</p> |
|  | <p>2031-050-DS</p> | <p>TAPA COMBUSTIBLE MAZDA MONTERO</p> | <p>TAIWAN</p> |
| | <p>2031050</p> | | <p>CAMEL</p> |



MG-05-01079

TAPA COMBUSTIBLE HYUNDAI ATOS - KIA TODOS-
CHRONOS (K.BF67 42 250)

GENUINE
PARTS



MG-05-01030

TAPA COMBUSTIBLE RENAULT 19 - PEUGEOT

GENUINE
PARTS



GPM-053

TAPA COMBUSTIBLE RENAULT KANGOO (7701472643)

GPM



MG-05-01023

TAPA COMBUSTIBLE RENAULT KANGOO 97 (7701472643)

GENUINE
PARTS

| | | | |
|---|----------------------|--|----------------------|
|  | <p>MG-05-01025</p> | <p>TAPA COMBUSTIBLE RENAULT CLIO CON LLAVE</p> | <p>GENUINE PARTS</p> |
|  | <p>MG-05-01261</p> | <p>TAPA COMBUSTIBLE RENAULT LOGAN-SANDERO-MASTER II-SCENIC (7701471585 7701470950)</p> | <p>GENUINE PARTS</p> |
|  | <p>GPM-020</p> | <p>TAPA COMBUSTIBLE LOGAN-SANDERO-CLIO-TWINGO-MEGANE-SCENIC (770141005)</p> | <p>GPM</p> |
|  | <p>MG05-01072</p> | <p>TAPA COMBUSTIBLE DE ROSCA 43MM UNIVERSAL</p> | <p>GENUINE PARTS</p> |
|  | <p>897095-686-2G</p> | <p>TAPA COMBUSTIBLE NKR-NPR GRIS M.N</p> | <p>TAIWAN</p> |
| | <p>RD-21216</p> | <p>TAPA COMBUSTIBLE NKR-NPR NEGRA M.N</p> | <p>TAIWAN</p> |

| | | | |
|--|-------------|--|---------------|
|  | GPM-038 | TAPA COMBUSTIBLE NPR-NKR (8970956862) | GPM |
| | MG-05-01102 | | GENUINE PARTS |
|  | RD-21217 | TAPA COMBUSTIBLE NKR-NPR METÁLICA GRANDE | TAIWAN |
|  | MG05-01072 | TAPA COMBUSTIBLE UNIVERSAL CON ROSCA PLÁSTICA | GENUINE PARTS |
|  | EG-763 | TAPA COMBUSTIBLE UNIVERSAL CON ROSCA Y LLAVE PLÁSTICA *PEUGEOT | TAIWAN |
| | MG-05-01145 | | GENUINE PARTS |
|  | GPM-051 | TAPA COMBUSTIBLE UNIVERSAL CON LLAVES (EG794E-EG799E-EG851E) | GPM |
| | MG-05-01160 | | GENUINE PARTS |

| | | | |
|---|-------------|--|---------------|
|  | MG-05-01161 | TAPA COMBUSTIBLE UNIVERSAL (E805E EF50) | GENUINE PARTS |
|  | WG100 | TAPA COMBUSTIBLE UNIVERSAL CAMPERO METÁLICA CON LLAVE 33MM | TAIWAN |
|  | 2431012 | TAPA RADIADOR SENCILLA | CAMEL |
|  | RD-14087 | TAPA RADIADOR 9LB INJECTION METÁLICO | TAIWAN |
|  | DSA-5109-4 | TAPA RADIADOR 4 LIBRAS METÁLICA | TAIWAN |
| | DSA-5109-7 | TAPA RADIADOR 7 LIBRAS METÁLICA | TAIWAN |
| | DSA-5109-9 | TAPA RADIADOR 9 LIBRAS METÁLICA | TAIWAN |
| | DSA-5109-13 | TAPA RADIADOR 13 LIBRAS (9KG) METÁLICA | TAIWAN |

| | | | |
|---|-------------|--|---------------|
|  | MG-05-01087 | TAPA RADIADOR UNIVERSAL 0.9K-1.1K (G.W.871) | GENUINE PARTS |
|  | MG-05-01089 | TAPA RADIADOR UNIVERSAL 0.9K-1.1K | GENUINE PARTS |
|  | MG-05-01086 | TAPA RADIADOR CHEVROLET 0.9 PSI SWIFT 1.3/1.6 /SPRINT 98/ SAMURAI/ MAZDA 323 / FORD FESTIVA /LASER /TY COROLLA (G.W.862) | GENUINE PARTS |
|  | MG-05-01080 | TAPA RADIADOR KIA (KK731-15-205A) | GENUINE PARTS |
|  | MG-05-01095 | TAPA RADIADOR NISSAN (21430-01F02) | GENUINE PARTS |
|  | DTEFE-01 | TEFLÓN CINTA 10 METROS | TAIWAN |
| | DSA-28001 | TERMICO 30 AMPERIOS CON PLATINA | TAIWAN |
| | 228-001 | | KTC |

| | | | |
|---|--------------|---|--------|
| | DSA-28004 | TERMICO 40 AMPERIOS CON PLATINA | TAIWAN |
| | 228-004 | | KTC |
|  | TS-35AMP | TERMINAL COBRE PARA SOLDAR 35AMP | TAIWAN |
| | TTS-50 | TERMINAL COBRE PARA SOLDAR 50AMP | TAIWAN |
| | TS-70AMP | TERMINAL COBRE PARA SOLDAR 70AMP | TAIWAN |
| | TTS-100 | TERMINAL COBRE PARA SOLDAR 100AMP | TAIWAN |
| | TS-125AMP | TERMINAL COBRE PARA SOLDAR 125AMP | TAIWAN |
| | TTS-150 | TERMINAL COBRE PARA SOLDAR 150AMP | TAIWAN |
| | TS-200AMP | TERMINAL COBRE PARA SOLDAR 200AMP | TAIWAN |
| | TS-250AMP | TERMINAL COBRE PARA SOLDAR 250AMP | TAIWAN |
|  | DSA-13010901 | TERMINAL DE OJO CUERPO DELGADO (DIAMETRO INTERIOR 5MM- ALTURA 25MM - GROSOR 0.58MM) | TAIWAN |
|  | DSA-13010902 | TERMINAL DE OJO 4.3MM CUERPO DELGADO | TAIWAN |
|  | DSA-13010904 | TERMINAL DE OJO 8.4MM CUERPO DELGADO | TAIWAN |
|  | DSA-13011001 | TERMINAL DE OJO CUERPO DELGADO (DIAMETRO INTERIOR 8MM- ALTURA 27MM - GROSOR 0.48MM) | TAIWAN |
|  | TL-3-16 | TERMINAL DE OJO 3/16 CUERPO DELGADO (5.2mm) | TAIWAN |

| | | | |
|---|-----------|---|--------|
|  | 235-017 | TERMINAL OJO 1/4 - DIAMETRO (6.4mm) | KTC |
| | TL-1.4 | TERMINAL DE OJO 1/4-CUERPO DELGADO REFORZADA (6.4mm) MS2425 | TAIWAN |
|  | MS-2426 | TERMINAL DE OJO 1/4 CUERPOGRUESO REFORZADA (6.4mm) | TAIWAN |
| | TL-5-16 | TERMINAL DE OJO 5/16 CUERPO GRUESO (8.4mm) | TAIWAN |
|  | DSA-53231 | TERMINAL DE OJO 3/8 (6.5mm) | TAIWAN |
|  | TL-1.8 | TERMINAL DEL OJO 1/8 CUERPO DELGADO | TAIWAN |
| | TL-5.32 | TERMINAL DE OJO 5/32 CUERPO DELGADO | TAIWAN |





| | | | |
|---|---------------|---|--------|
|  | TD-2108 | TERMINAL ENCHUFE HEMBRA MEDIANA CON REJILLA Y PIN T-093 | TAIWAN |
| | 235-258 | TERMINAL ENCHUFE HEMBRA PARA SOCKET DE UNIDAD H4 | KTC |
| | DJ-621 | TERMINAL ENCHUFE HEMBRA 6.3 CON REJILLA Y PIN T-094 *COBRE | TAIWAN |
|  | TAIWAN-621PLT | TERMINAL ENCHUFE HEMBRA 6.3 CON REJILLA Y PIN T-095 *PLATEADO | TAIWAN |
|  | AY-47R | TERMINAL ENCHUFE HEMBRA GRANDE PIN REFORZADA T-094 | TAIWAN |

| | | | |
|---|----------|--|--------|
|  | TD-2131 | TERMINAL ENCHUFE HEMBRA GRANDE T-095 | TAIWAN |
|  | AY-48 | TERMINAL ENCHUFE MACHO PIN PLANA-COBRE | TAIWAN |
| | TE-2308 | | TAIWAN |
| | 235-005 | | KTC |
| | SQ-033 | TERMINAL PARLANTE HEMBRA CON PIN | TAIWAN |
| | 235-009 | TERMINAL PARLANTE HEMBRA CON PIN | KTC |
|  | SQ-033-R | TERMINAL PARLANTE HEMBRA CON PIN *REFORZADAD | TAIWAN |
|  | 235-006 | TERMINAL PARLANTE MACHO CON PIN | KTC |



| | | | |
|---|----------------|---|--------|
|  | IM-185 | TERMINAL PARLANTE MACHO CON PIN | TAIWAN |
|  | TAIWAN-AY45 | TERMINAL TUBULAR HEMBRA - REDONDA | TAIWAN |
|  | TAIWAN-AY44 | TERMINAL TUBULAR MACHO - REDONDA | TAIWAN |
|  | DSA-AY45-DBPLT | TERMINAL TUBULAR HEMBRA-REDONDA DOBLE CROMADO | TAIWAN |
|  | TAIWAN-AY45-DB | TERMINAL TUBULAR HEMBRA-REDONDA DOBLE CROMADO | TAIWAN |
|  | TAIWAN-9001 | TERMOENCOGIBLE 1MM ROLLO X 200MT | TAIWAN |
| | TAIWAN-9002 | TERMOENCOGIBLE 2MM ROLLO X 400MT | TAIWAN |
| | TAIWAN-9003 | TERMOENCOGIBLE 3MM ROLLO X 200MT | TAIWAN |
| | TAIWAN-9004 | TERMOENCOGIBLE 4MM ROLLO X 200MT | TAIWAN |

| | | | |
|---|----------------|---|--------|
|  | TAIWAN-9005 | TERMOENCOGIBLE 5MM ROLLO X 200MT | TAIWAN |
| | TAIWAN-9006 | TERMOENCOGIBLE 6MM ROLLO X 200MT | TAIWAN |
| | TAIWAN-9007 | TERMOENCOGIBLE 7MM ROLLO X 100MT | TAIWAN |
| | TAIWAN-9008 | TERMOENCOGIBLE 8MM ROLLO X 100MT | TAIWAN |
| | TAIWAN-9009 | TERMOENCOGIBLE 9MM ROLLO X 100MT | TAIWAN |
| | TAIWAN-9010 | TERMOENCOGIBLE 10MM ROLLO X 100M | TAIWAN |
|  | 258-017 | TERMOSTATO SPRINT-SWIFT 1.3-FORSA II-LANCER 82°C (17600-82860) | KTC |
|  | PLUGHEAD-LONG | TORRE BUJÍA INJECTION LARGA *N9/N12 | TAIWAN |
|  | 234-H6054 | UNIDAD SELLADA HALÓGENA RECTANGULAR GRANDE 12V 65/35W DOT 142mmX200mm 3C | KTC |
|  | 234-H5006-100W | UNIDAD SELLADA HALÓGENA REDONDA PEQUEÑA 5 3/4" 12V 100/100W DOT 3C | KTC |

| | | | |
|---|--------------------|---|---------------|
|  | <p>234-H5006</p> | <p>UNIDAD SELLADA HALÓGENA REDONDA PEQUEÑA 5 3/4"12V DOT 35/35W 3C</p> | <p>KTC</p> |
|  | <p>DSA-2008703</p> | <p>LUZ TRASERA LED 3 COLORES 24LED 12/24V *MEDIAS - FRENO - DIRECCIONAL (NJ-134M)</p> | <p>TAIWAN</p> |
|  | <p>DSA-7-12V</p> | <p>VENTILADOR CABINA 6" 12V METÁLICO NEGRO</p> | <p>TAIWAN</p> |
|  | <p>319-100-12V</p> | <p>VENTILADOR CABINA 6" 12V METÁLICO NEGRO</p> | <p>KTC</p> |
|  | <p>DSA-7-24V</p> | <p>VENTILADOR CABINA 6" 24V METÁLICO NEGRO TRABAJO PESADO 1PC</p> | <p>TAIWAN</p> |

| | | | |
|---|---------------|--|--------|
|  | 319-100-24V | VENTILADOR CABINA 6" 24V METÁLICO NEGRO TRABAJO PESADO 1PC | KTC |
|  | DSA-105-12V | VENTILADOR CABINA 8" 12V NEGRO METÁLICO TRABAJO PESADO 1PC | TAIWAN |
|  | DSA-105-24V | VENTILADOR CABINA 8" 24V NEGRO METÁLICO TRABAJO PESADO 1PC | TAIWAN |
|  | DSA-106-12V-E | VENTILADOR METÁLICO OSCILANTE CON ASPAS EN PLÁSTICO CLIP 6" Y ENCENDEDOR 12V 1PC | TAIWAN |
| | 319-106-12V-E | | KTC |
| | DSA-106-24V-E | | TAIWAN |

| | | | |
|---|-----------|--|--------|
|  | FAN-6-12V | VENTILADOR CABINA 6" 12V ASPA PLÁSTICO Y PINZA DE AGARRE | TAIWAN |
|  | 216067-DS | VOLTÍMETRO 12V 52MM TABLERO BLANCO-ARO NEGRO | TAIWAN |
| | 216-067 | | KTC |
|  | DSA-16010 | VOLTÍMETRO 12V 52MM TABLERO NEGRO-ARO CROMADO GPM | TAIWAN |
| | 216-010 | | GPM |
|  | 216-032 | VOLTÍMETRO 12V 52MM TABLERO NEGRO-ARO NEGRO | KTC |
| | ST-155 | | TAIWAN |
|  | 216-057 | VOLTÍMETRO 12V 52MM TABLERO BLANCO-ARO CROMADO | GPM |

| | | | |
|---|---------|---|-----|
|  | 216-033 | VOLTÍMETRO 24V 52MM TABLERO NEGRO-ARO NEGRO | KTC |
|  | 216-011 | VOLTÍMETRO 24V 52MM TABLERO NEGRO-ARO CROMADO | GPM |

